

Kraken Dock Lighting System Installation Instructions

Models: 101638 – Command Center

101680 – Secondary Power Supply

101636 – Dock Light, White/Blue

101637 – Dock Light, Spectrum

WARNING

WARNING: RISK OF ELECTRIC SHOCK

- **Lumitec Kraken Systems should be installed by qualified persons only.**
- Use only in bodies of water, ponds and small decorative fountains where persons will immerse no more than their hands and lower arms while the product is energized.
- DO NOT use in water intended for swimming, wading, immersion, or bathing.
- All installer completed cable connections must be located outside of bodies of water, pond or fountain.
- Low voltage circuit must be supplied by a power unit marked as suitable for supplying submersible luminaires.
- Power unit must be supplied by a circuit protected by a ground fault circuit interrupter (GFCI).
- Maximum depth: 8 feet
- All installer completed cable connections must be located outside of bodies of water, pond or fountain. Take careful consideration of tidal shift if connections are completed under docks, or near waterline.

WARNING: For your safety read and understand instructions before starting installation. Before permanently wiring to branch circuit, turn off electricity at the fuse or circuit breaker box. Before attempting any installation check your applicable electric code. This code sets the wiring standards and should be carefully studied before starting.

Note: All statements, technical information and recommendations contained herein are based on information and tests we believe to be reliable. The accuracy or completeness thereof are not guaranteed. In accordance with “Terms and Conditions of Sale”, and since conditions of use are outside our control, the purchaser should determine the suitability of the product for his intended use and assumes all risk and liability whatsoever in connection therewith.

IMPORTANT:

Read carefully before installing fixture. Retain for future reference.

APPLICATION: Kraken Dock Lighting Systems are designed for outdoor wet locations, where moisture, dirt, corrosion may be present. Underwater dock lights are intended for full submersion in fresh and salt water.

Listed models of Kraken Dock Lighting System can be operated at the following voltages:

UNIVERSAL 100VAC - 300VAC 50/60Hz

Underwater light Installation

Note: Pilings should be cleaned to remove hard growth that would prevent the light from having a stable base to install against.

Note: Nylon ties are 40 inches long and should provide enough length to wrap around a 9-inch square or 11-inch round piling.

Note: It is helpful in tidal locations that this part of the installation be performed close to low tide.

1. Slide 1 nylon tie through slot in the back of the light housing. Wrap clamp around piling and feed free end of clamp back through clamp latch and back through slot in light housing.
2. Adjust so that light is approximately 6 inches below water line at a typical low tide for your area.
3. Tension clamp by holding light with one hand and pulling cable with the other. It may help to pull the free end of the clamp with pliers.
4. Use a second nylon tie or other fastener if needed to secure power cable to piling. Prevent abrasion by routing cable to side of piling away from vessel access.

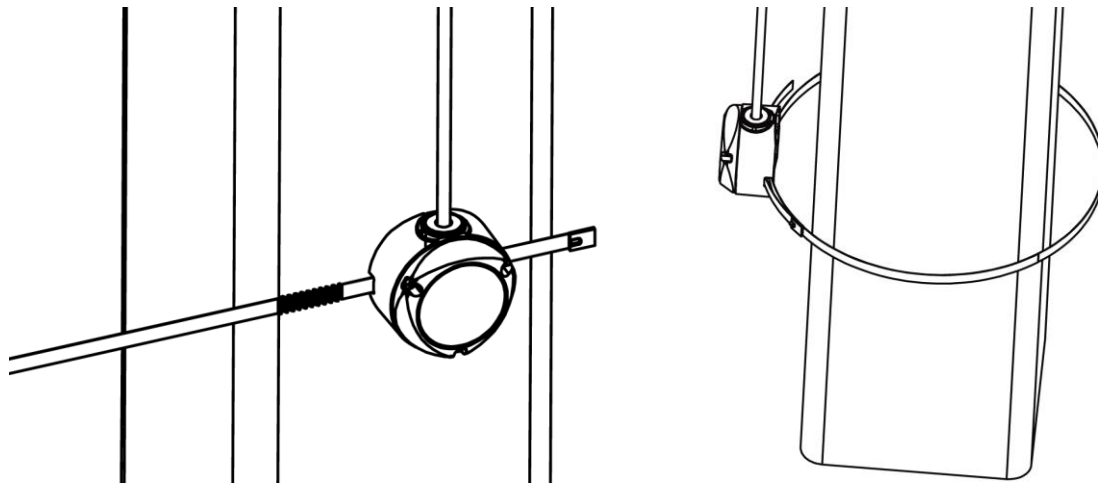

Power Unit Installation

Note: This fixture is suitable for installation in wet locations.

1. Determine the mounting location of the Power Unit ensuring all underwater light cables reach the supply and are routed to prevent abrasion from vessels or other moving components.
2. Attach the power unit to suitable structure at least 1 foot above ground level with the high and low voltage cables pointing down. The metal plate on the back of the power unit enclosure MUST be offset a minimum of 0.28" (7mm) for proper air-flow. NOTE: Do not energize transformer until installation of system is complete

Electrical Connection

Note: Fixture may be switched with a timer, photodetector, or toggle switch prior to the receptacle. DO NOT connect power unit to a dimmer. Light connected to the POCO digital control outputs can be controlled by Bluetooth, Wi-Fi, or Network connection with the POCO controller through a mobile device or network connected computer.

Note: Use approved outdoor (While in use) weatherproof receptacle cover to protect cord and outlet from weather while plugged in.

Note: Supplemental grounding is highly recommended. See page eight (8) for surge protection.

Note: Provide electrical service according to the electric code for your specific application from a suitable ground fault circuit interrupter (GFCI) receptacle.

1. All high voltage components in the fixture are prewired so electrical connection only needs to be made on the secondary (24VDC low voltage) side of the power supply. NOTE: the power unit is rated for 480W max load. Do not connect more than 6 Kraken underwater lights to this supply.
2. Split low voltage cable back approximately 6 inches and strip conductors back 3/8 inch if not already done so.
3. Insert low voltage cables into cable glands on the bottom of the power unit. Tighten cable glands until the cables are secure.

For 2 wire "PLI" Lumitec DC lights: Connect the red (+) wires to either of the 1,2,3, or 4 Digital Control Channel Outputs. Channel Outputs are indicated by brown and orange connectors inside the Power Unit Enclosure. Channels 1 and 2 combined are not to exceed 10 Amps total. Channels 3 and 4 combined are not to exceed 10 Amps total. Connect all black (-) wires to the Black Universal Ground Bus.

For 3 wire "PLI" Lumitec DC lights: Connect the red (+) wires directly to the Red 24VDC Constant Bus. Connect all black (-) wires to the Black Ground Bus. Connect orange (remote) to either of the 1,2,3, or 4 Digital Control Channel Outputs. Channel Outputs are indicated by brown and orange connectors inside the Power Unit Enclosure. **Note: The orange wire draws a negligible current and 6 Kraken light's orange wires can be connected to a single channel.**

DC Breakers: There are 3 breakers within the Power Unit enclosure. A single 20 Amp breaker is dedicated to the constant 24VDC (+) Bus. There are two 10 Amp breakers. One of the 10 Amp breakers is shared between channels 1 and 2 outputs. The additional 10 Amp breaker is shared between channels 3 and 4 outputs.

DC Wiring Schematic: Shown below is a wiring schematic inside the Power Unit enclosure. Use this schematic and the instructions listed above for proper DC device wiring.

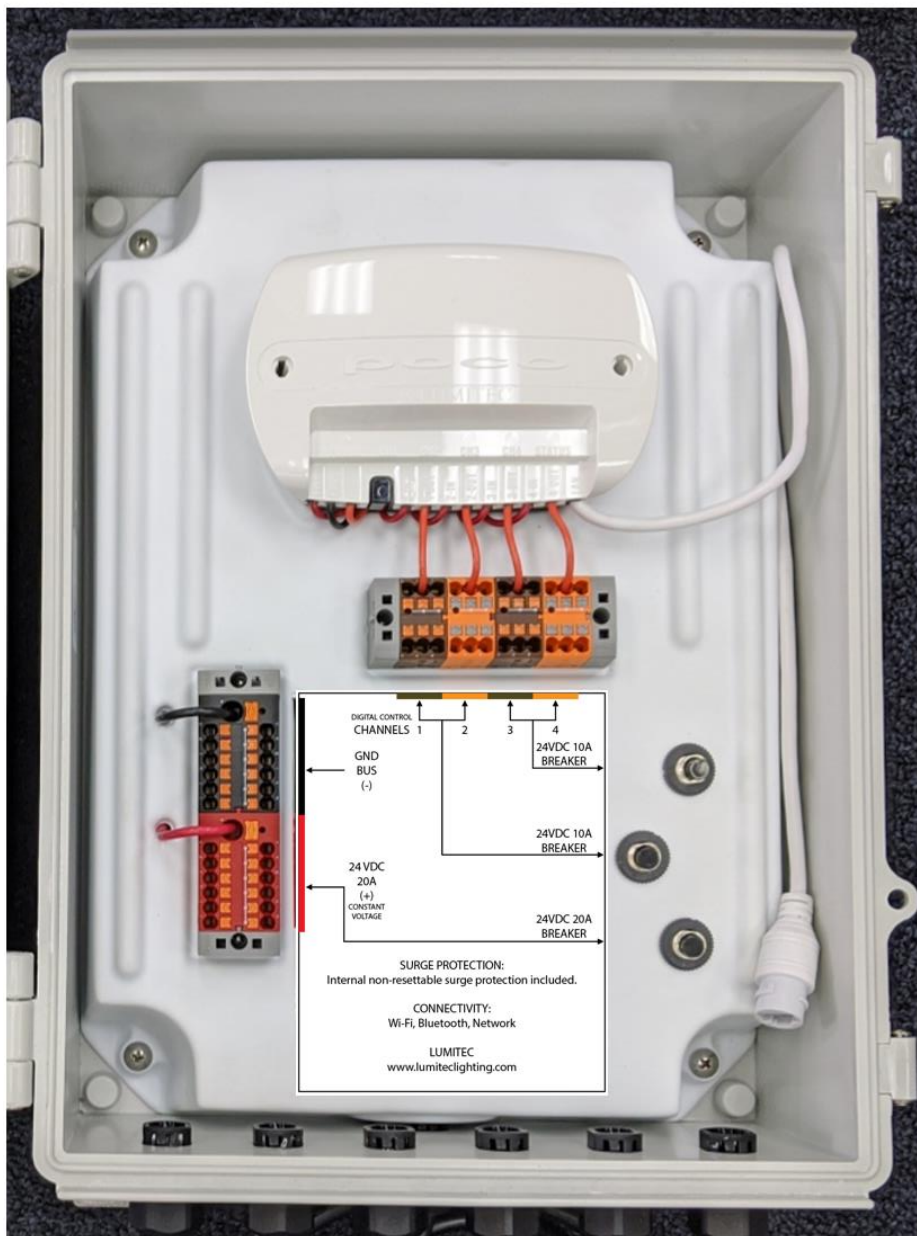

Digital Control

Operating Lights Using POCO Digital Control

IMPORTANT: To use the supplied information provided within this quick start guide all lights installed must be PLI compatible. For lights that are non-PLI, or a non Lumitec brand, refer to our website at <http://lumiteclighting.com/check4pli> for additional installation information.

STEP 1: Plan and Install Your Digital Lighting System

CALCULATE YOUR AMP DRAW AT THE LIGHT FIXTURES

Channels 1 and 2 combined: Total Amp draw must be below 10 Amps

Channels 3 and 4 combined: Total Amp draw must be below 10 Amps

STEP 2: Connect To POCO

- A. Poco can be connected to a network connected computer and/or a mobile device through WiFi.
- B. For mobile devices connect using the Lumitec Poco App available on Apple or Google Play stores. You will be prompted to connect to Poco on launching the app.
- C. To setup the Kraken system on your home network, first connect directly to the WiFi on Kraken device you are installing. When setting up multiple units it may be helpful to keep the power off on the remaining units until the device you are setting up has been named. Using a laptop or mobile device, connect to the WiFi network named "**Poco-XXXX**" with the password found on the Poco information label (see image below) on the inside of the front cover. You can also use a compatible smart device to connect via the QRC code.



- D. Open a Safari, Firefox, or Chrome web browser and type IP address: **192.168.4.1**
- E. Select the Gear icon in the upper right of the page to start configuring the network enter the default password **0000**. Click on the Maintenance Page.
- F. Under Maintenance, Select "**Configure Ethernet/WiFi**"
- G. Enable Station mode by selecting "**Go to AP+STA mode**"
- H. Now connect to your home WiFi. Activate Scanning to find your network by clicking "**Scan!**"
- I. Select network and type in the password.
- J. Once connected, a Kraken command unit will appear under HTTP list in the connection screen of the App on a mobile device. This allows for control of the Kraken lighting system from anywhere in the house and is no longer limited to the Bluetooth range of the command module.

Helpful Details:

- Default configuration password: 0000
- Default Wi-Fi Password: Found on information label on inside front cover
- Wi-Fi web access to user interface: 192.168.4.1

STEP 3: Create Light Groups

Select configuration in the setting menu (top right of screen). Assign Channel and Clan for each light location in your landscape (underwater lights, piling lights etc.). **Examples:**

Name: LG_Piling Lights Channel: 1 Clan: 11: Piling Lights Output: Lumitec Spectrum RGBW	Name: LG_1,2,3 UW Lights Channel: 2 Clan: 4: Underwater Lights Output: Lumitec Spectrum RGBW
Name: LG_Pathway Lights Channel: 1 Clan: 10 – Pathway Lights Output: Two color, white and blue	Name: LG_4,5,6 UW Lights Channel: 3 Clan: 4: Underwater Lights Output: Lumitec Spectrum RGBW

STEP 4: Create Switches

Assign a default intensity and color to each switch.

Example Simple Switch:

Name: Piling Lights

Target: LG_Piling Lights **Intensity:** 50% **Color:** Red

You can create lighting scenes by assigning multiple light groups to more than one target.

Example Scene Switch:

Name: Night Fishing

- Target:** LG_Pathway Lights **Intensity:** 20% **Color:** Red
- Target:** LG_1,2,3 UW Lights **Intensity:** 20% **Color:** Red
- Target:** LG_4,5,6 UW Lights **Intensity:** 100% **Color:** Green

STEP 5: Add Switches to Layout Pages

- A. Select the desired layout tab for your switch. Note: Layout tabs can be added, deleted, or re-named at any time.

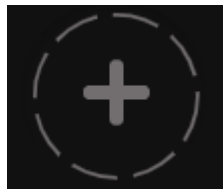

- B. Select the plus (+) button symbol.
- C. Select desired switch from list.

Note: Go to <http://lumiteclighting.com/poco-quick-start> for more detailed information.

TROUBLESHOOTING: Check Status Indicators

POWER Indicator –

Illuminates Green if POCO is powered on, both PWR and ACC lines must have supply voltage between 10-30vDC

CH1, CH2, CH3 or CH4 Indicator –

- Illuminates Red if power is supplied to channel from fuse/breaker panel.
- Illuminates Green if power is supplied to channel input and channel is turned on inside of POCO controller; PLI enabled lights may be OFF.
- Flashes Orange if PLI data is transmitted.
- Illuminates Orange if channel is dimmed through a PWM signal

STATUS Indicator –

Green blinking light indicates WiFi connection status:

- 0 blinks: WiFi disabled
- 1 blink: WiFi enabled but not connected to any peers
- 2 blinks: WiFi is connected to one or more peers

Blue blinking light indicates Bluetooth-LE connection status:

- 0 blinks: Bluetooth-LE is disabled
- 1 blink: Bluetooth-LE enabled but not connected
- 2 blinks: Bluetooth-LE is connected

Surge Arrestor Installation for Outdoor AC Installations

A surge protection device (SPD) has been installed in your Kraken system. Warranty claims may be denied if an SPD has not been installed according to the recommendations in this document. Damaging voltage fluctuations can occur from other equipment attached to the AC supply or due to induced voltages from direct and indirect lightning strikes. Indirect lightning strikes can be especially problematic because the voltage will be induced even at long distances from the strike location and is typically a function of the wire length. Outdoor lighting projects typically have longer wiring and tend to be subjected to higher induced voltages, which increases the need for SPD installation.

To prevent lightning damage to your equipment, Lumitec recommends installing a supplemental grounding system to the one found at the service point. The grounding system directs lightning-induced electrical current into the earth rather than allowing the surge to pass through power wires or field wires to your equipment. The Kraken enclosure comes with a ground lug external to the enclosure.

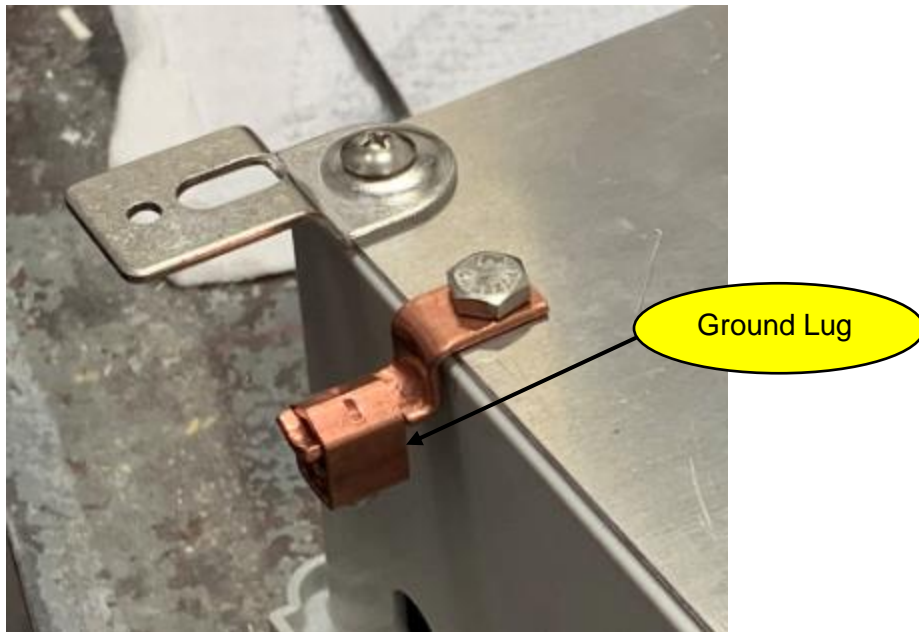

A good grounding system should maintain a resistance of 10 ohms or less to ground. Ground resistance occurs when grounding system components, or the soil itself, oppose the flow of electricity into the earth. The higher the ground resistance (higher ohm readings), the higher the chance the surge will damage the equipment's electronic components rather than be shunted to ground. If you are unable to reach a resistance of 10 ohms or less, you can enhance the ground network with additional ground electrodes or plates.

All grounding rods or plates must be connected with #6 AWG or larger solid copper wire. Install the connecting wire in as straight a line as possible. If you must make a turn or bend in the wire, make the turn in a sweeping curve with a minimum radius of 8 inches. Ground rod corrosion will increase the ground resistance and decrease the effectiveness of the SPD. Use the correct material for your installation environment. Copper plated, solid copper, and stainless-steel ground rods are options to consider. Do not use galvanized grounding rods for this application.

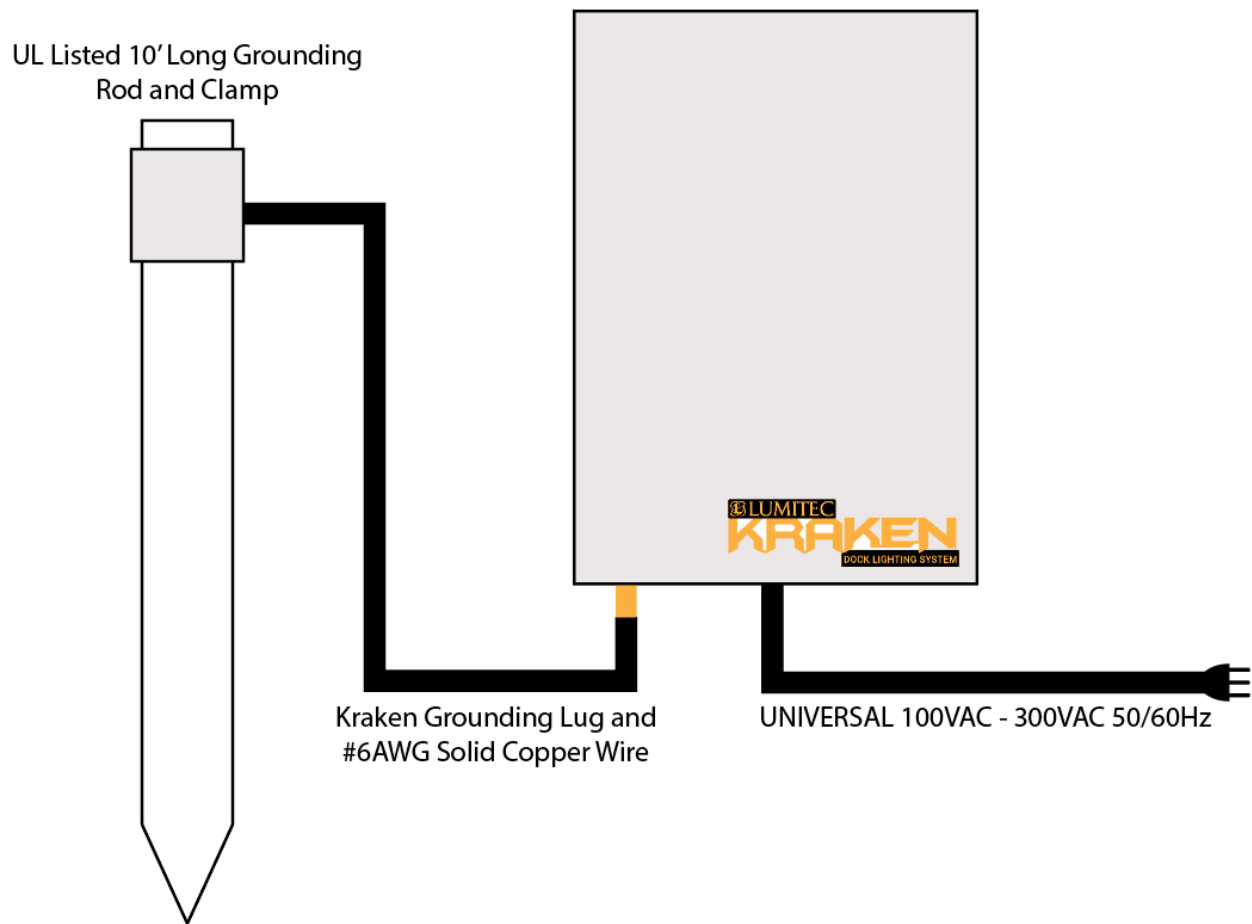

Kraken Dock Lighting Instructions for Custom Installs

Installation with 1 controller and multiple power supplies

Custom Lumitec Kraken installations that exceed the maximum current of a single power supply (PSU) can be extended by installing additional PSUs. Lumitec provides the following wiring principals illustrated below as guidance.

With this method of installation, the power and color of your Kraken lights can be controlled using a toggle switch or controlled with the Lumitec Poco Digital Lighting Controller. The Kraken underwater dock lights are powered through the Red and Black wires and controlled through the orange data wire as shown in Figure 1.

3-WIRE CONNECTION

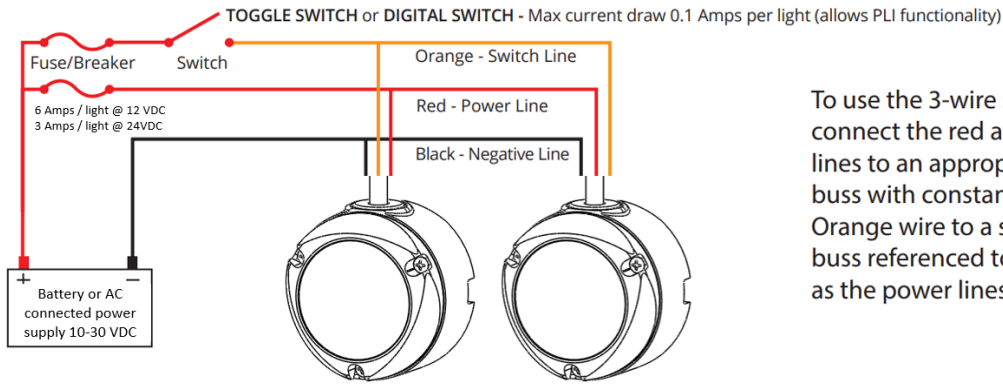

To use the 3-wire system, simply connect the red and black 10-30VDC lines to an appropriately fused power buss with constant power and the Orange wire to a switched +10-30VDC buss referenced to the same ground as the power lines.

Figure 1: Kraken wiring diagram. Basic installation.

To use a single controller for Kraken underwater lights on multiple PSUs, the control signal orange wire (data) and black wire (ground) must be run to each light as shown in Figure 2. Lumitec strongly advises the use of optocouplers to isolate each PSU from the others in the system. This is recommended to lower the risk that nearby lightning strikes and electrical surges that could damage all interconnected systems if an isolation barrier is not provided.

Figure 2 provides information on recommended components as well as the suggested wiring configuration. Lumitec has tested and recommends using WAGO optocoupler part number 859-758 for transmitting the digital control signal without distortion. For additional details on lightning protection see the section in this manual titled Surge Arrestor Installations.

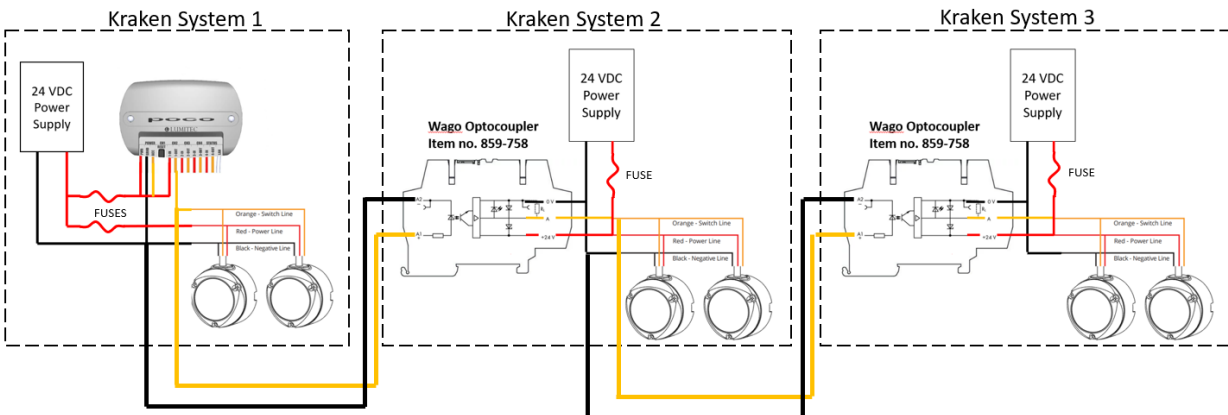

Figure 2: Multiple Kraken Supplies controlled from a single Poco

Custom Enclosure Recommendations

Lumitec recommends installing the AC to DC power supply (PSU) within an enclosure that provides heat dissipation. If a plastic enclosure is used, and no means for air circulation is provided, then the power supply may go into a fault state and stop supplying power to the load until the temperature drops down to a safe level. Typical AC to DC switching supplies are approximately 94% efficient, and 6% of the

energy is wasted as heat. As an example, a 480-Watt supply can create 29 Watts of heat when fully loaded.

If metal enclosures are used, follow applicable NEC requirements for the grounding of dead metal.

Challenges can also occur when using metal enclosures with the Poco Digital Lighting Control unit. Be aware that metal enclosures are not compatible with WIFI or Bluetooth connectivity.

MAINTENANCE

- The lens should be cleaned monthly to ensure continued lighting performance. To clean, brush the lens with a stiff plastic bristled brush. Do not use a scraper, abrasive, strong alkaline, or acid cleaner. Damage may result.
- Visually check for undue heating evidenced by discoloration of wires or other components, damaged parts, or leakage evidenced by water or corrosion in the interior, some small amount of water is allowed on the interior of the power supply. Replace all worn, damaged, or malfunctioning components and clean before putting the luminaire back into service.
- Electrically check to make sure that all connections are clean and tight.
- Mechanically check that all parts are properly assembled.

Replacement Parts

Lumitec LED underwater lights are designed to provide years of reliable lighting performance. However, should the need for replacement parts arise, they are available through Lumitec Lighting. Contact us at www.lumiteclighting.com.

Please refer to <http://lumiteclighting.com/support/warranty/> for warranties and claims.

The product is warranted to be free from defects in workmanship and materials for a period of three (3) years from the date of original purchase.

Lumitec is not responsible for product failure caused by abuse, neglect, improper installation, or failure in applications other than those for which it was designed, intended, and marketed. Lumitec, Inc. assumes no responsibility whatsoever for any damage, loss, or injury that may result from the incorrect installation of this product, including but not limited to structural damage due to water intrusion, electrical malfunction or vessel sinking when used in marine applications.

Should your Lumitec product prove defective during the warranty period, promptly notify Lumitec for a return authorization number and return product with freight prepaid. Lumitec will, at its option, repair or replace the product or defective portion without charge for parts or labor, or, at Lumitec's option, refund purchase price. Products repaired or replaced under this warranty shall be warranted for the unexpired portion of the warranty applying to the original product(s). No warranty or affirmation of fact, express or implied, other than as set forth in the limited warranty statement above is made or authorized by Lumitec, Inc. Any liability for consequential and incidental damages is expressly disclaimed. Lumitec liability in all events is limited to, and shall not exceed, the purchase price paid.

Any alterations, modifications or changes of any type made to the Kraken Dock Lighting System or to any component thereof will void the warranty.

Manufacture Corporate Headquarters:

Lumitec

1405 Poinsettia Drive, Suite 10

Delray Beach, FL 33444

Phone: (561) 272-9840

Fax: (561) 272-9839

Email: info@lumiteclighting.com

Web: www.lumiteclighting.com