



2024 LIGHTING PRODUCT GUIDE

| MARINE | TERRESTRIAL | DOCK & DECK | CUSTOM/SPECIALTY APPLICATIONS | DIGITAL LIGHTING CONTROL |

A photograph of a white outboard motor on a boat, viewed from the rear. The motor is illuminated from below by a bright green light, which reflects on the water. The background shows a sunset over a body of water, with a dark horizon line and a sky transitioning from orange to blue. The text "| PERFORMANCE | RELIABILITY | QUALITY |" is overlaid in white, sans-serif font across the center of the image.

| PERFORMANCE | RELIABILITY | QUALITY |



Lumitec is an engineering and design firm solely focused on the conceptualization, development, and manufacture of high-quality extreme environment LED lighting. Our LED fixtures are designed with an in-depth understanding of each light's application and use environment. We leverage this knowledge among our team of highly skilled engineers and designers working in our state-of-the-art LED R&D facility to deliver leading-edge innovation, best-in-class performance, exceptional reliability, and unsurpassed quality.

CONTACT INFORMATION:

Sales:

Tel. 561.272.9840

Fax. 561.272.9839

Email. sales@lumiteclighting.com

Address:

Lumitec

1055 SW 15th Avenue, Suite 7

Delray Beach, Florida 33444

TABLE OF CONTENTS:

Digital Lighting Control	03
Flood Lights	05
Specialty Flood Lights	09
Positionable Lights	10
Interior Down Lights	11
Dome Lights	16
Utility Lights	17
Courtesy & Accent Lights	21
Underwater Lights	23
Surface Mount Underwater Lights	27
Wet Space Lights	29
Navigation Lights	30
Dock & Deck Lighting Systems	33
Customer Support/Warranty	38



lumiteclighting.com

Digital Lighting Control

Lumitec's Poco Digital Lighting Control is a powerful, cost-effective on-board lighting control solution. It provides fingertip touch control of Lumitec PLI-enabled lights through a compatible MFD or connected smart device via a simple, easy-to-install control module.

Expandable through the incorporation of Pico Modules, the Poco system offers the same level of sophisticated lighting control previously found only on high-end yachts.





Poco Module
3.5" W X 5.5" H X 1.25" D

Poco™ Digital Control Module

Poco Digital Lighting Control delivers powerful, low-cost, on-board lighting control through a compatible MFD or connected smart device in a simple, easy to install control module.

Suitable for new builds or refits, the Poco 3 Digital Control Module is compact and completely sealed. Because it replaces physical circuits, wires, and switches, builders will often find that they can save money while offering their customers the sophisticated control previously found only on high-end yachts. When installed with Lumitec's PLI-enabled lights, even more functionality is unleashed – precise color selection and intensity, custom lighting scene creation and multiple 'virtual circuits' on a single channel, allowing aftermarket installers to add lights and improve on-board lighting designs without adding any additional wire runs.

Poco Digital Lighting Control Module

SKU	Description	Channels	Voltage	Amps
101699	Poco 3 Digital Lighting Control Module	4	10-30vDC	10A/ch

The Poco 3 Digital Control Module can be controlled through a compatible MFD or connected smart device (not included).



Power Line
Instruction



IP Rated



3 Year
Warranty

Applies to Poco and
all Pico Modules

Pico Modules (S8 & C4)
2" W X 2.75" H X 0.5" D

Pico C4-MAX
3.1" W X 3.5" H X 0.88" D

Pico Module (OHM)
1.5" W X 1.35" H X 0.3" D



Pico S8

Pico C4

Pico C4 Max

Pico OHM

Sold in
packs of 4

Pico™ Expansion Modules

Pico Expansion Modules are designed to expand the capabilities of the already powerful Poco Digital Lighting Control system. There are currently four modules available.

Pico C4 - provides TTP functionality or Poco control of third-party RGB or RGBW lighting accessories such as lighted speakers and LED boat lettering. Max load of 2.5A.

Pico C4-MAX - Similar function to the standard C4 but with higher output and incorporates a low current signal wire control to reduce the load on the Poco channels. 10A max load.

Pico S8 - provides the ability to assign Poco virtual switch commands to mechanical switches (8 max). Physical switch will activate the virtual switch command through the Poco module.

Pico OHM - provides efficient Poco-only control of third-party RGB lighting accessories (no TTP). Connects in-line at RGB accessory, 400mA max load. Sold in packs of four (4) modules.

SKU	Description	Voltage	Max Amps
101609	Pico C4 Module	10-30vDC	2.5A
101873	Pico C4-MAX Module	10-30vDC	10A
101684	Pico S8 Module	10-30vDC	100mA
101829	Pico OHM Module (4 pack)	10-16vDC	400mA

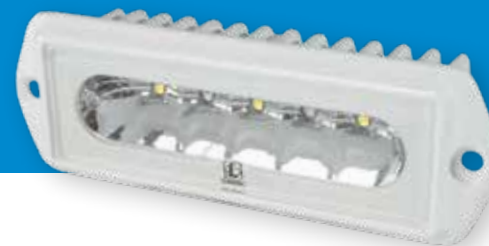
CapriLT4.94" W X 1.75" H X 1.57" D
Mounting Hole Size: 3.96" W X 1.36" H**Capri2**4.94" W X 1.75" H X 1.57" D
Mounting Hole Size: 3.96" W X 1.36" H**CapreraLT**

4.49" W X 1.98" H X 2.58" D

Available with
black housing**Caprera2**

4.49" W X 1.98" H X 2.58" D

Available with
black housing

CapriLT/CapreraLT

With more than 1,000 integrating sphere tested lumens†, the versatile and lightweight CapriLT and CapreraLT are the undisputed value-leaders in the spreader lights category. The LT delivers exceptional reliability, class-leading performance, and has been rigorously tested for shock, vibration, water ingress, and overall durability - in short, exceptional value in extreme environment LED flood lighting. Compatible with most PWM** LED dimmers. IP67 compliant.

1K
Lumen
Output3PD
Third Party
DimmerCM
Color Match
CommitmentIP67
IP RatedV+
2-Wire
Hookup3
3 Year
WarrantyCE
European
Conformity

SKU	FINISH	COLOR OUTPUT	CRI*	CCT*	VOLTAGE	12VDC	24VDC	LUMENS†
CapriLT								
101288	White	White Non-Dimming	70+	5000	10-30vDC	1.3A	600mA	1000
101289	Black	White Non-Dimming	70+	5000	10-30vDC	1.3A	600mA	1000
CapreraLT								
101292	White	White Non-Dimming	70+	5000	10-30vDC	1.3A	600mA	1000
101293	Black	White Non-Dimming	70+	5000	10-30vDC	1.3A	600mA	1000

** Pulse Width Modulation (PWM)

* Lumens, CRI & CCT applies only to white light.

W=Width, H=Height, D=Depth, Dia=Diameter

† Integrating sphere measured lumens within 1 minute of initial startup

Capri2/Caprera2

Lumitec's Capri2/Caprera2 flood lights add more features to the Capri/Caprera line. Two-color technology provides amazing white output with elegant blue or night-vision preserving red and dimming in all colors. Our exclusive wide beam optical technology puts the light where you need it most, providing up to twice the usable light of competitors. Fully sealed & IP67 compliant. TTP and PLI enabled - Poco System Compatible.

1K
Lumen
Output3PD
Third Party
DimmerCM
Color Match
CommitmentIP67
IP RatedTTP
Timed Toggle
ProtocolPLI
Power Line
InstructionCE
European
Conformity

Dimming

3
3 Year
Warranty

SKU	FINISH	COLOR OUTPUT	CRI*	CCT*	VOLTAGE	12VDC	24VDC	LUMENS†
Capri2								
101099	White	White Dimming, Blue Dimming	70+	5000	10-30vDC	1.3A	600mA	1000
101100	White	White Dimming, Red Dimming	70+	5000	10-30vDC	1.3A	600mA	1000
101186	Black	White Dimming, Blue Dimming	70+	5000	10-30vDC	1.3A	600mA	1000
101187	Black	White Dimming, Red Dimming	70+	5000	10-30vDC	1.3A	600mA	1000
Caprera2								
101102	White	White Dimming, Blue Dimming	70+	5000	10-30vDC	1.3A	600mA	1000
101103	White	White Dimming, Red Dimming	70+	5000	10-30vDC	1.3A	600mA	1000
101217	Black	White Dimming, Blue Dimming	70+	5000	10-30vDC	1.3A	600mA	1000
101218	Black	White Dimming, Red Dimming	70+	5000	10-30vDC	1.3A	600mA	1000

Capri Retrofit Kit Available

Easy Fit
Spring clip fasteners that require no mounting hardware.



Capri3
4.08" W X 1.39" H X 1.43"D
Mounting Hole Size: 3.86" W X 1.24" H

Caprera3
3.79" W X 1.10" H X 2.49" D



Available with black housing



5.76" W X 2.8" H X 4.1" D



Spectrum Halo™

Capri3/Caprera3

The Capri3/Caprera3 builds on the huge success of the Capri/Caprera line of spreader lights. Now with 1,200 lumens, a smaller, more thermally efficient powder-coated die-cast aluminum housing with improved optical beam pattern and no exposed fasteners on flush mount lights. But the innovation doesn't stop there; Capri3 has our innovative easy fit butterfly clip mounting system to greatly simplify the installation process. Capri3/Caprera3 is IP67 compliant and PLI enabled (Poco compatible) on many models.

HOUSING	COLOR OUTPUT	CRI*	CCT*	VOLTAGE	12VDC	24VDC	LUMENS†
Capri3							
White	Black						
101720	101725	RGBW Spectrum	70+	5000	10-30vDC	1A 0.5A	1200
101721	101726	White Dimming, Blue Dimming	70+	5000	10-30vDC	1A 0.5A	1200
101722	101727	White Dimming, Red Dimming	70+	5000	10-30vDC	1A 0.5A	1200
101723	101728	White Non-Dimming	70+	5000	10-30vDC	1A 0.5A	1200
101724	101729	White Dimming	70+	5000	10-30vDC	1A 0.5A	1200
Caprera3							
White	Black						
101710	101715	RGBW Spectrum	70+	5000	10-30vDC	1A 0.5A	1200
101711	101716	White Dimming, Blue Dimming	70+	5000	10-30vDC	1A 0.5A	1200
101712	101717	White Dimming, Red Dimming	70+	5000	10-30vDC	1A 0.5A	1200
101713	101718	White Non-Dimming	70+	5000	10-30vDC	1A 0.5A	1200
101714	101719	White Dimming	70+	5000	10-30vDC	1A 0.5A	1200

Corsica Inset Flood Light

Sleek, clean, and powerful, the Corsica Inset Flood Light is a new addition to the mold-in Contour series. Corsica's design allows it to be sculpted into hardtops, wheelhouses, or arches for a cohesive and integrated look. Corsica delivers more than 1,200 darkness-piercing lumens and is our first light to feature the all-new Spectrum Halo™ accent light. Spectrum Halo™ casts an even, dimmable, colored glow while enhancing a vessel's nighttime aesthetics. TTP and PLI enabled, Corsica can be controlled with any normal on/off switch and is also compatible with our Poco Digital Lighting Control system.

CONTOUR SERIES

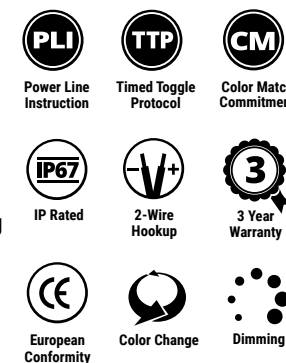

SKU	FINISH	COLOR OUTPUT	CRI*	CCT*	VOLTAGE	12VDC	24VDC	LUMENS†
101611	White	White with Spectrum Halo™	70+	5000	10-30vDC	1A	500mA	1200

* Lumens, CRI & CCT applies only to white light.
W=Width, H=Height, D=Depth, Dia=Diameter
† Integrating sphere measured lumens within 1 minute of initial startup

6,000+ Lumens

Trunnion Mount
7.13" W X 3.15" H X 2.6" D



Available with
black housing

Flush Mount
8.3" W X 2.72" H X 2.5" D
Mounting Hole Size: 7.2" W X 2.44" H

Maxillume h60

From the world's top custom yacht builders to the US Coast Guard, customers with high expectations rely on the Maxillume h60 flood light. Packing more than 6,000 TRUE lumens[†] (dimmable), the h60 is available with two mounting options and our tried and tested internal dimmer control. Each light is completely water sealed (IP67 compliant) and rigorously tested for shock and vibration. The h60 is PLI enabled (Poco compatible) and has a 3-wire configuration (additional orange signal wire).



SKU	FINISH	COLOR OUTPUT	CRI*	CCT*	VOLTAGE	12VDC	24VDC	LUMENS [†]
Trunnion Mount								
101334	White	White Dimming	70+	5000	10-30vDC	5A	2.5A	6000
101335	Black	White Dimming	70+	5000	10-30vDC	5A	2.5A	6000
Flush Mount								
101336	White	White Dimming	70+	5000	10-30vDC	5A	2.5A	6000

Flush Mount
9.6" W X 6.6" H X 3.1" D
Mounting Hole Size: 8.2" W X 5.7" H

12,000+ Lumens



Available with
black housing

Trunnion Mount
8" W X 6" H X 3.32" D

Maxillume h120

The Maxillume h120 has set the standard in DC-powered deck/work lights. Delivering more than 12,000 TRUE lumens[†] (dimmable) and housed in a heavy-duty powder-coated die-cast aluminum housing. The polished 316 Stainless Steel bracket on the trunnion mount version offers maximum flexibility for positioning and will ensure the light stays put through rigorous vibration and shock. The h120 is PLI enabled (Poco compatible) and has a 3-wire configuration (additional orange signal wire).



SKU	FINISH	COLOR OUTPUT	CRI*	CCT*	VOLTAGE	12VDC	24VDC	LUMENS [†]
Trunnion Mount								
101346	White	White Dimming	70+	5000	10-30vDC	10A	5A	12,000
101347	Black	White Dimming	70+	5000	10-30vDC	10A	5A	12,000
Flush Mount								
101348	White	White Dimming	70+	5000	10-30vDC	10A	5A	12,000

* Lumens, CRI & CCT applies only to white light.
W=Width, H=Height, D=Depth, Dia=Diameter

† Integrating sphere measured lumens within 1 minute of initial startup

20,000+
Lumens



Semi-Recessed
17.25" W X 9.12" H X 1.5" D
Mounting Hole Size: 15.5" W X 7.25" H

Trunnion Mount
13.7" W X 7.8" H X 3.76" D

Surface Mount
13.7" W X 5.1" H X 2.36" D

Maxillume tr150

Rugged, reliable, with 20,000 TRUE lumens[†] - the Maxillume tr150 will change the way you work at night. Rock solid reliability and a durable powder-coated die-cast aluminum construction guarantees light when you need it. Your crew will be safer, faster, more effective, and more productive. Completely sealed to IP67 standards and tested to military specifications for shock and vibration. The Maxillume tr150 is the new standard for 200W LED spot/flood lighting.



SKU	MOUNT	BEAM	VOLTAGE	CRI*	CCT*	12VDC	24VDC	LUMENS [†]
101413	Trunnion	Flood	10-36vDC	70+	5000	17.5A	8.75A	20,000
101414	Recessed	Flood	10-36vDC	70+	5000	17.5A	8.75A	20,000
101415	Surface	Flood	10-36vDC	70+	5000	17.5A	8.75A	20,000
101416	Trunnion	Spot	10-36vDC	70+	5000	17.5A	8.75A	20,000

† Integrating sphere measured lumens within 1 minute of initial startup

* Lumens, CRI & CCT applies only to white light.

W=Width, H=Height, D=Depth, Dia=Diameter

† Integrating sphere measured lumens within 1 minute of initial startup

10,000+
Lumens



Flood

Available with spot or flood beam pattern.

Spot

Available with black housing

18" W X 1.5" H X 3.5" D

Razor™ Light Bar

Sleek, streamline, and powerful, Razor is specifically designed for marine applications. PLI enabled (Poco compatible) with a 3-wire configuration the Razor Light Bar is designed to be easily integrated into most existing hardtop, arch, and pilothouse designs, or it can surface-mount directly to unmodified hardtop surfaces for an equally clean look. But don't let the small footprint fool you, Razor packs a punch with over 10,000 night-piercing lumens of dimmable light. Available in two beam patterns, spot, or flood with a choice of a white or black finish.



SKU	FINISH	BEAM	VOLTAGE	CRI*	CCT*	12VDC	24VDC	LUMENS [†]
101586	White (Dimming)	Flood	10-30vDC	70+	5000	9A	4.2A	10,000
101587	White (Dimming)	Spot	10-30vDC	70+	5000	9A	4.2A	10,000
101588	Black (Dimming)	Flood	10-30vDC	70+	5000	9A	4.2A	10,000
101589	Black (Dimming)	Spot	10-30vDC	70+	5000	9A	4.2A	10,000

Also available with an inverted center logo for inverted applications.



Available with white or black base



2.75" Dia. X 2" D



White

6.36" W X 1.75"H X 1.48" D



Available with Stainless Steel housing

Zephyr Spreader/Deck Light

The Zephyr spreader light is equally well suited to lighting the fore-deck of an elegant sloop or the cockpit of a sport yacht. Mounted on spreaders, spars, radar arches or towers, and fly-bridges at a mounting height of 16 feet, this spreader light brightly illuminates an area nearly 24 feet in diameter with more than 1,000 lumens[†]. Positionable, sleek and versatile with unsurpassed reliability - meaning no more costly and complex bulb replacements.

- 1K
Lumen Output
- 3PD
Third Party Dimmer
- CM
Color Match Commitment
- IP67
IP Rated
- 2-Wire Hookup
- 3
3 Year Warranty
- CE
European Conformity

SKU	FINISH	COLOR OUTPUT	CRI*	CCT*	VOLTAGE	12VDC	24VDC	LUMENS [†]
101325	Brushed/White	White	70+	5000	10-30vDC	1.3A	600mA	1000
101326	Brushed/Black	White	70+	5000	10-30vDC	1.3A	600mA	1000

* Lumens, CRI & CCT applies only to white light.

W=Width, H=Height, D=Depth, Dia=Diameter

† Integrating sphere measured lumens within 1 minute of initial startup

Perimeter Light

The Perimeter Light is versatile, attractive, and powerful. With more than 1,000 true lumens[†] and an optical system designed to spread light very widely and evenly, it is uniquely suited to various specialty applications. Use it overhead in cramped service spaces for offset illumination of critical mechanical components. Or mount it on vertical exteriors of pilot houses, cabins, or even terrestrial vehicles or trailers for bright, even perimeter illumination. Aluminum housing and impact-resistant plastic window means years of trouble-free service even in the most extreme environments.

- 1K
Lumen Output
- 3PD
Third Party Dimmer
- CM
Color Match Commitment
- IP67
IP Rated
- TTP
Timed Toggle Protocol
- 3
3 Year Warranty
- CE
European Conformity
- PLI
Power Line Instruction
- Dimming

SKU	FINISH	COLOR OUTPUT	CRI*	CCT*	VOLTAGE	12VDC	24VDC	LUMENS [†]
101475	White	White Non-Dimming (Non TTP)	70+	5000	10-30vDC	1.3A	600mA	1000
101476	White	White Dimming, Blue Dimming	70+	5000	10-30vDC	1.3A	600mA	1000
101477	White	White Dimming, Red Dimming	70+	5000	10-30vDC	1.3A	600mA	1000
101478	White	White Dimming, Amber Flashing	70+	5000	10-30vDC	1.3A	600mA	1000

Also available with Stainless Steel housing, contact sales support for SKU numbers.



Brushed
1.49" Dia X 2.53" D
Mounting Hole Size: 0.375" Dia. (3/8")



White



Brushed
2.4" Dia X 3" D
Mounting Hole Size: 0.375" Dia.



White



GAI2

The General Area Illumination (GAI) light is a versatile light in an elegant package. Fully positionable and available in various finishes and outputs, the GAI is perfect as a reading light in a cabin, a task light in the salon, or chart light in a navigation station. Fully sealed and IP67 compliant the GAI makes for a great exterior deck light.

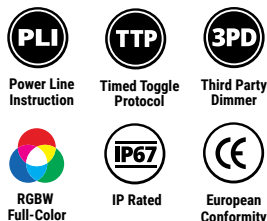

GAI2 Heavy Duty Base (with switch)

The versatile General Area Illumination (GAI) light is also available with a solid aluminum heavy duty base (switched or unswitched) for applications requiring a more durable mounting option. GAI is fully sealed and IP67 compliant (unswitched only) making it perfect for exterior use.

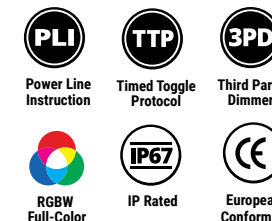

SKU	FINISH	COLOR OUTPUT	CRI*	CCT*	VOLTAGE	12VDC	24VDC	LUMENS†
111809	Brushed	Warm White Dimming (Hi CRI)	90+	3000	10-30vDC	480mA	260mA	250
111808	Brushed	White Dimming, Red Non-Dimming, Blue Non-Dimming	80+	5000	10-30vDC	430mA	230mA	340
111807	Brushed	RGBW Spectrum	80+	5000	10-30vDC	430mA	230mA	340
111810	White	Warm White Dimming (Hi CRI)	90+	3000	10-30vDC	480mA	260mA	250
111828	White	White Dimming, Red Non-Dimming, Blue Non-Dimming	80+	5000	10-30vDC	430mA	230mA	340
111827	White	RGBW Spectrum	80+	5000	10-30vDC	430mA	230mA	340

SKU	FINISH	COLOR OUTPUT	CRI*	CCT*	VOLTAGE	12VDC	24VDC	LUMENS†
111801	Brushed	Warm White Dimming (Hi CRI)	90+	3000	10-30vDC	480mA	260mA	250
111800	Brushed	White Dimming, Red Non-Dimming, Blue Non-Dimming	80+	5000	10-30vDC	430mA	230mA	340
111830	Brushed	RGBW Spectrum	80+	5000	10-30vDC	480mA	230mA	340
111803	White	Warm White Dimming (Hi CRI)	90+	3000	10-30vDC	480mA	260mA	250
111802	White	White Dimming, Red Non-Dimming, Blue Non-Dimming	80+	5000	10-30vDC	430mA	230mA	340
111831	White	RGBW Spectrum	80+	5000	10-30vDC	430mA	230mA	340

* Lumens, CRI & CCT applies only to white light.

W=Width, H=Height, D=Depth, Dia=Diameter

† Integrating sphere measured lumens within 1 minute of initial startup

Interior Down Lights

Delivering incredible output with profiles that are among the slimmest in the industry, Lumitec's Down Lights remain the best-performing products in the category. IP67 rated and completely sealed making them perfectly suited for a variety of indoor or outdoor overhead lighting needs. Enhance textures and surfaces with output options that include architectural-grade High CRI warm white and full-color RGBW Spectrum, offering nearly infinite output color possibilities.



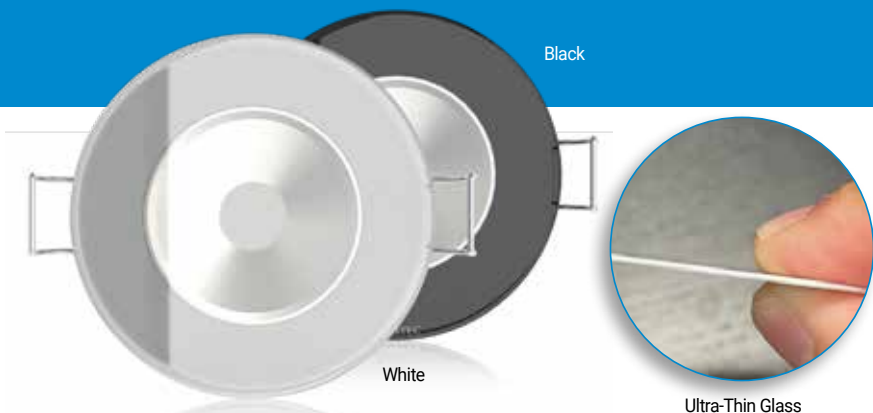

The Illusion Series by Lumitec

The Illusion Series is our latest family of products guaranteed to add a new level of sophistication and refinement to the Lumitec line up. Designed to have an ultra-thin profile with a seamless clean look, Illusion Series products incorporate state-of-the-art industry-first materials and manufacturing processes. Unique in styling and highly versatile in appearance options the Illusion Down Light will launch the series.

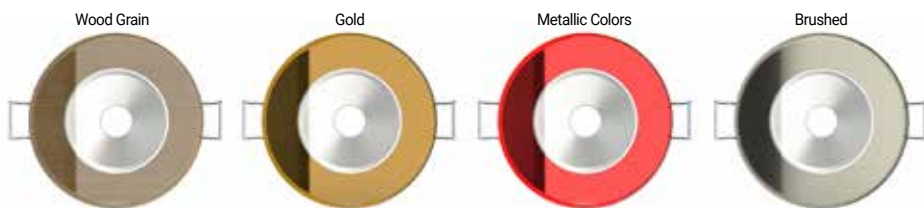

Advanced manufacturing techniques will allow for the face of the Illusion light to be highly customizable. For more information on this feature contact your account representative.

Illusion™ Down Light

Introducing the Illusion Down Light . Sleek and stylish with an ultra-thin bezel-free design the Illusion Down Light provides for a seamless flush mount integration on hardtops, arches, and salon ceilings. Boasting chemically hardened wafer-thin glass with a shorter mounting depth than the Mirage, Illusion retains the convenient butterfly clip mounting system for no exposed fasteners. Advanced manufacturing techniques allow for the light face to adapt multiple finish options including the “illusion” of a bezel, on the one piece, flush mounted, easy to clean face. The Illusion Series Down Light will include a new “Light to Sound” synchronization feature when paired to a compatible Poco module. Color output options will include warm white/spectrum, cool white/spectrum, and single color warm and cool white output. IP67 compliant.

WHITE	WHITE/MIRROR ACCENT	BLACK	COLOR OUTPUT	CRI*	CCT*	VOLTAGE	12VDC	24VDC	LUMENS†
117123	117133	117153	White Non-Dimming	80+	5000	10-30vDC	360mA	180mA	172
117129	117139	117159	Warm White Dimming	90+	3000	10-30vDC	480mA	260mA	300
117127	117137	117157	RGBW Cool White Spectrum	80+	5000	10-30vDC	430mA	230mA	380
117125	117135	117155	RGBW Warm White Spectrum	80+	5000	10-30vDC	430mA	230mA	380

* Lumens, CRI & CCT applies only to white light. W=Width, H=Height, D=Depth, Dia=Diameter

**Only 6 watt lights, have output greater than a 20 watt halogen in white mode

† Integrating sphere measured lumens within 1 minute of initial startup

3.25" Dia. X 1" D
Mounting Hole Size: 2" Dia.



Polished



White

2.5" Dia. X 1" D
Mounting Hole Size: 2" Dia.



Glass



Available with black frit and housing

3.5" Dia. X 1" D @ 0°, 2" D @ 33.5°
Mounting Hole Size: 2.875" Dia.



POSITIONABLE MIRAGE

MIRAGE

Mirage/Positionable Mirage/Square Mirage Flush Mount Down Lights

The Mirage Down Light series remain the best-performing down lights in the category. Delivering incredible output and a profile that is among the slimmest in the industry. Completely sealed and IP67 rated, it is perfectly suited for a variety of indoor or outdoor overhead lighting needs. Output options include architectural-grade High CRI warm white, white/blue/red multi-color, and RGBW Spectrum, offering nearly infinite output color possibilities.

The Mirage series now include positionable (gimbal) and square models. The Positionable Mirage offers up to 30 degrees of pivot for wall wash, art lighting, and other dramatic lighting effects. The Square Mirage blends harmoniously with today's more contemporary and forward-thinking designs. All boast Mirage's industry-leading output, features, and contemporary good looks.

Mirage Features:



Timed Toggle Protocol



Third Party Dimmer



Color Match Commitment



Power Line Instruction



IP Rated



European Conformity



3 Year Warranty



2-Wire Hookup



Color Change



Dimming



Color Cycle



RGBW Full-Color



POSITIONABLE MIRAGE
Angle of Rotation

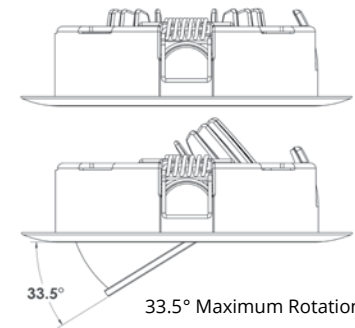

3.45" W X 3.45" H X 1" D
Mounting Hole Size: 2" Dia.



Polished

3.45" W X 3.45" H X 1" D
Mounting Hole Size: 2" Dia.



White

2.63" W X 2.63" H X 1" D
Mounting Hole Size: 2" Dia.



Glass

SQUARE MIRAGE

Available in 6 watt outputs or 3 watt "white non-dimming"



SKU: White	Glass	Polished	COLOR OUTPUT	CRI*	CCT*	VOLTAGE	12VDC	24VDC	LUMENS†
MIRAGE									
113120	113190	113110	White Non-Dimming, Red Non-Dimming, Blue Non-Dimming, Purple Non-Dimming	80+	5000	10-30vDC	430mA	230mA	380
113123	113193	113113	White (Dimming 3PD Only)	80+	5000	10-30vDC	360mA	180mA	172
113128	113198	113118	White Dimming, Red Non-Dimming, Blue Non-Dimming	80+	5000	10-30vDC	430mA	230mA	380
113129	113199	113119	Warm White Dimming (Hi CRI)	90+	3000	10-30vDC	480mA	260mA	300
113127	113197	113117	RGBW Spectrum	80+	5000	10-30vDC	430mA	230mA	380
SQUARE MIRAGE									
116128	116198	116118	White Dimming, Red Non-Dimming, Blue Non-Dimming	80+	5000	10-30vDC	430mA	230mA	380
116129	116199	116119	Warm White Dimming (Hi CRI)	90+	3000	10-30vDC	480mA	260mA	300
116127	116197	116117	RGBW Spectrum	80+	5000	10-30vDC	430mA	230mA	380
POSITIONABLE MIRAGE									
115128	N/A	115118	White Dimming, Red Non-Dimming, Blue Non-Dimming	80+	5000	10-30vDC	430mA	230mA	380
115129	N/A	115119	Warm White Dimming (Hi CRI)	90+	3000	10-30vDC	480mA	260mA	300
115127	N/A	115117	RGBW Spectrum	80+	5000	10-30vDC	430mA	230mA	380

* Lumens, CRI & CCT applies only to white light. W=Width, H=Height, D=Depth, Dia=Diameter

**Only 6 watt lights, have output greater than a 20 watt halogen in white mode

† Integrating sphere measured lumens within 1 minute of initial startup

2" Dia. X 0.75" D
Mounting Hole Size: 1.25" Dia.



Brushed



White

2" Dia. X 0.75" D
Mounting Hole Size: 1.25" Dia.



Brushed



White



Orbit Retrofit Kit

SPECTRUM
COLOR

SPECTRUM
COLOR

Halo

Class-leading output, weatherproof construction, and one of the simplest installations in the industry. With a shallow-depth profile (less than 1/2" mounting depth) and a secure composite mounting system, the lights are ideal for a variety of indoor and outdoor uses. Intelligent circuitry enables advanced features like dimming and multi-color control without external control modules, specialized switches, or additional wire runs. Completely sealed and IP67 compliant.

Halo/Orbit
Features:



Timed Toggle
Protocol



Third Party
Dimmer



Color Match
Commitment



Power Line
Instruction



IP Rated



European
Conformity



3 Year
Warranty



2-Wire
Hookup



Color Change



Dimming



RGBW
Full-Color

Only available in 3 watt outputs

HALO

ORBIT

BRUSHED	WHITE	BRUSHED	WHITE	COLOR OUTPUT	CRI*	CCT*	VOLTAGE	12VDC	24VDC	LUMENS†
112800	112820	112500	112520	White Non-Dimming, Red Non-Dimming, Blue Non-Dimming, Purple Non-Dimming	80+	5000	10-30vDC	430mA	230mA	340
112803	112823	112503	112523	White (Dimming 3PD Only)	80+	5000	10-30vDC	360mA	180mA	160
112808	112828	112508	112528	White Dimming, Red Non-Dimming, Blue Non-Dimming	80+	5000	10-30vDC	430mA	230mA	340
112809	112829	112509	112529	Warm White Dimming (Hi CRI)	90+	3000	10-30vDC	480mA	260mA	250
112807	112827	112507	112527	RGBW Spectrum	80+	5000	10-30vDC	430mA	230mA	340

* Lumens, CRI & CCT applies only to white light.

W=Width, H=Height, D=Depth, Dia=Diameter

† Integrating sphere measured lumens within 1 minute of initial startup

Orbit

Orbit Down Lights stand apart from the crowd with a shallow-depth profile (less than 1/2" mounting depth) and a secure composite mounting system. The lights are ideal for a variety of indoor and outdoor uses (IP67 compliant).

The Orbit Retrofit Kit covers oversized holes (1.875" to 2.750") from old style halogen lights. The ingenious clamp-in design has no exposed fasteners for a clean look inside and out.



Stainless Steel



6.75" Dia X 1.13" D

CONTOUR
SERIES

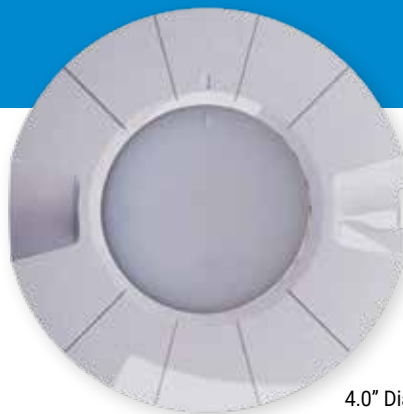

4.0" Dia X 0.73" D

Stainless Steel



4.0" Dia X 0.73" D

White



Touch Dome

Brilliant, innovative with a completely sealed design and no O-rings, baffles, or switches to wear out. Touch Dome promises reliable "touch" operation even when wet or wearing gloves. The proprietary Optical Field Sense technology provides on/off, color change, and even dimming. Ideal for switch free locations like galleys and heads. Touch Dome is beautifully designed and elegantly functional.

Aurora Flush Mount Dome Light

The Aurora Dome Light has been a long-standing favorite of OEMs, installers, and end-users. Loved for its faultless reliability, versatility, and performance. The Aurora Flush Mount Dome Light is one of the new additions to Lumitec's popular Contour line and offers a sleek, fully integrated design. Like its surface-mount sibling, output color and light intensity can be easily adjusted with a simple rotation of the bezel.

Aurora Surface Mount Dome Light

The high-quality Aurora Surface Mount Dome Light stands apart from other LED replacements for ubiquitous dome lights. Bright, with wide even light, a clean look, and an reliable, intuitive switch. Aurora offers multiple dual-color output options with dimming, IP67 immersion protection and a notable level of superior quality. It's no surprise that Aurora is a top seller with our OEM customers.

Touch Dome

SKU	FINISH	COLOR OUTPUT	CRI*	CCT*	VOLTAGE	12VDC	24VDC	LUMENS†
101097	Stainless Steel	White Dimming, Blue Dimming	70+	5000	10-30vDC	410mA	215mA	244
101098	Stainless Steel	White Dimming, Red Dimming	70+	5000	10-30vDC	410mA	215mA	244

Aurora Flush Mount

SKU	FINISH	COLOR OUTPUT	CRI*	CCT*	VOLTAGE	12VDC	24VDC	LUMENS†
101606	White	White Dimming, Blue Dimming	70+	5000	10-30vDC	330mA	210mA	180
101605	White	White Dimming, Red Dimming	70+	5000	10-30vDC	330mA	210mA	180

Aurora Surface Mount

SKU	FINISH	COLOR OUTPUT	CRI*	CCT*	VOLTAGE	12VDC	24VDC	LUMENS†
101138	Stainless Steel	White Dimming, Blue Dimming	70+	5000	10-30vDC	330mA	210mA	180
101139	Stainless Steel	White Dimming, Red Dimming	70+	5000	10-30vDC	330mA	210mA	180
101075	White	White Dimming, Blue Dimming	70+	5000	10-30vDC	330mA	210mA	180
101076	White	White Dimming, Red Dimming	70+	5000	10-30vDC	330mA	210mA	180

* Lumens, CRI & CCT applies only to white light.

W=Width, H=Height, D=Depth, Dia=Diameter

† Integrating sphere measured lumens within 1 minute of initial startup

Utility Lighting

The unsung heroes of the lighting world, utility lights provide much needed functionally. Lumitec offers a wide range of utility lighting products, from engine room and compartment lights to full-color under gunwale lighting, that are guaranteed to complement any lighting configuration.

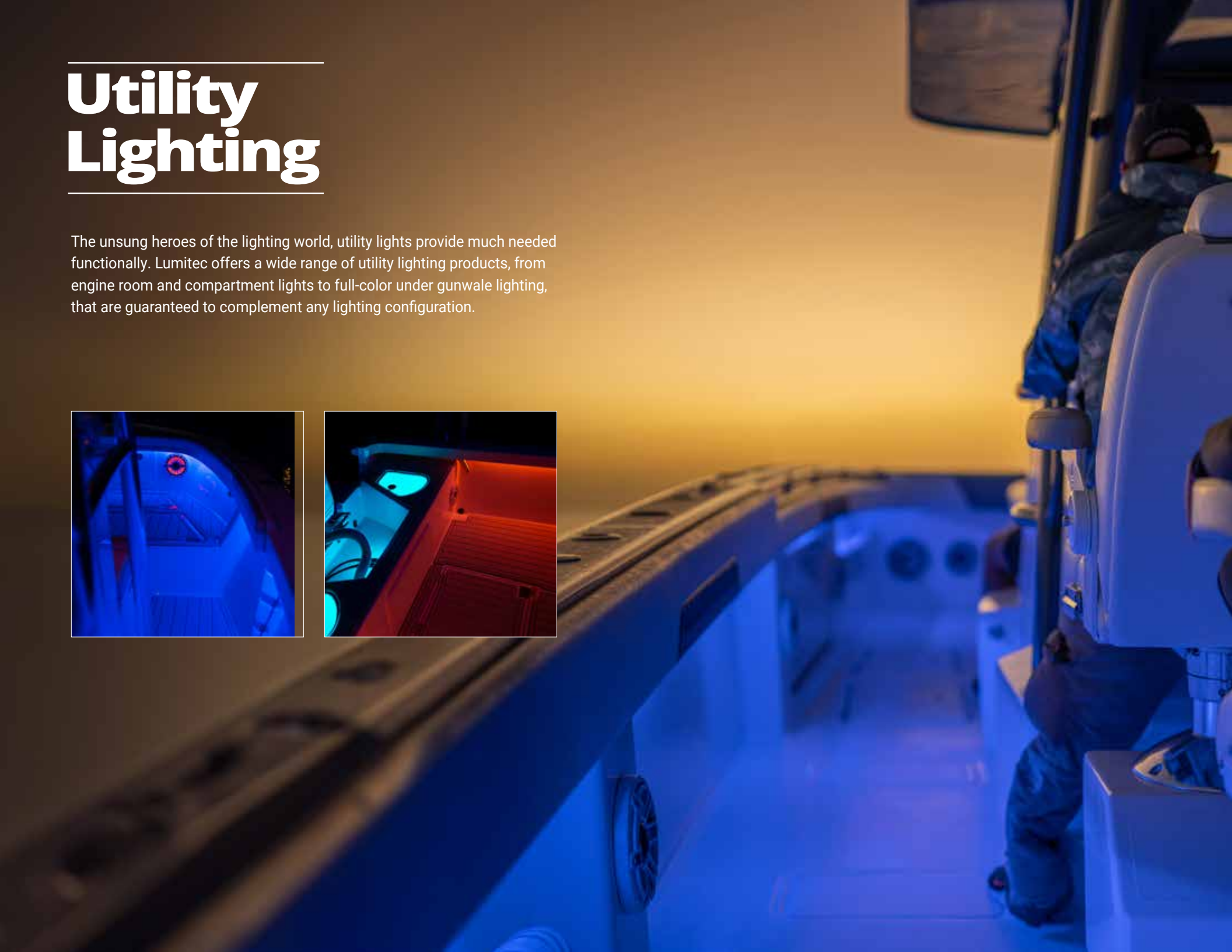
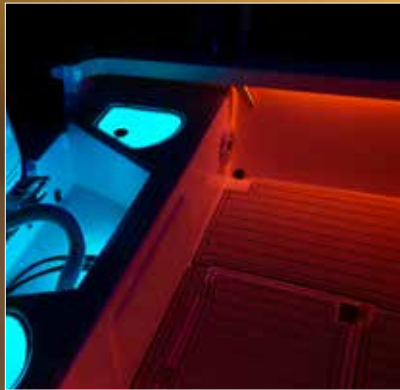



Rail2
11.72" W X 1.11" H X 0.60" D

Mini Rail2
5.9" W X 1.11" H X 0.60" D

Moray Flex Light - With Integrated Lighting Controller

The Moray Flex Light is the only RGBW marine flex light to have an internal color output controller. This means that Moray can be connected directly to a 2-wire DC electrical system, allowing for color and dimming control with any standard on/off switch, with no external driver required. PLI enabled, Moray is also compatible with our Poco Digital Lighting Control system for advanced color control through an on-board MFD or smart device via a connected Poco module. Available in eight convenient sizes, Moray is the versatile and reliable flex light solution that will reduce wiring cost, time, and complexity.

White	Length	COLOR OUTPUT	CRI*	CCT*	VOLTAGE	12VDC	24VDC	LUMENS†
101647	1.5'	RGBW Spectrum	80+	5000	10-16vDC	312mA	N/A	113
101640	3'	RGBW Spectrum	80+	5000	10-16vDC	625mA	N/A	225
101648	4.5'	RGBW Spectrum	80+	5000	10-16vDC	938mA	N/A	338
101641	6'	RGBW Spectrum	80+	5000	10-16vDC	1.25A	N/A	450
101649	7.5'	RGBW Spectrum	80+	5000	10-16vDC	1.56A	N/A	563
101642	9'	RGBW Spectrum	80+	5000	10-16vDC	1.88A	N/A	675
101650	10.5'	RGBW Spectrum	80+	5000	10-16vDC	2.19A	N/A	788
101643	12'	RGBW Spectrum	80+	5000	10-16vDC	2.5A	N/A	900

* Lumens, CRI & CCT applies only to white light.

† Integrating sphere measured lumens within 1 minute of initial startup.

Rail2 & Mini Rail2

The versatile Rail2 12" light is available in warm white, 3-color, or full-color Spectrum output. The compact 6" Mini Rail2 is available in single color warm white, neutral white, blue, red, or full-color spectrum output. Both are ideal for interior or exterior covered spaces (downward facing orientation), and all multi-color options are Poco compatible.

SKU	FINISH	COLOR OUTPUT	CRI*	CCT*	VOLTAGE	12VDC	24VDC	LUMENS†
Rail2								
101243	Brushed	White Dimming, Red Non-Dimming, Blue Non-Dimming	70+	5000	10-30vDC	880mA	460mA	900
101242	Brushed	Warm White Dimming	80+	3000	10-30vDC	1.3A	600mA	800
101283	Brushed	RGBW Spectrum	70+	5000	10-30vDC	880mA	460mA	900
Mini Rail2								
101078	Brushed	White (Dim 3PD Only, Non PLI)	70+	5000	10-30vDC	360mA	180mA	145
101079	Brushed	Blue (Dim 3PD Only, Non PLI)	NA	NA	10-30vDC	360mA	180mA	NA
101080	Brushed	Red(Dim 3PD Only, Non PLI)	NA	NA	10-30vDC	160mA	100mA	NA
101241	Brushed	Warm White (Dim 3PD Only, Non PLI)	80+	3000	10-30vDC	360mA	180mA	95
101545	Brushed	RGBW Spectrum	70+	5000	10-30vDC	510mA	280mA	300

3.5" Dia. X 1" D
Mounting Hole Size: 2" Dia.



Shadow
Polished



Shadow
White



Anywhere Light
1.73" Dia. X 0.44" D



Shadow Utility Light

The Shadow surface/down light is versatile and tough, with an incredible output greater than a 20W halogen. Available with dimming and color change from a standard 2-wire hookup to any on/off switch. Completely sealed (IP67 compliant) and compatible with most PWM** LED dimmers.



Power Line
Instruction



Timed Toggle
Protocol



IP Rated



2-Wire
Hookup



European
Conformity



3 Year
Warranty

Anywhere Light

Where can you use a light that is attractive, bright, small, completely sealed, and withstands the elements yet blends with well-appointed interiors? Well, anywhere! This surface mount light is constructed with a quality aluminum housing and is completely water sealed to withstand the elements. IP67 compliant.



Power Line
Instruction



Timed Toggle
Protocol



IP Rated



2-Wire
Hookup



European
Conformity



3 Year
Warranty

White	Polished	COLOR OUTPUT	CRI*	CCT*	VOLTAGE	12VDC	24VDC	LUMENS†
114120	114110	White, Red, Blue, Purple, Non-Dimming	80+	5000	10-30vDC	430mA	230mA	380
114123	114113	White (Dim 3PD Only, Non PLI)	80+	5000	10-30vDC	360mA	180mA	172
114128	114118	White Dimming, Red, Blue, Non-Dimming,	80+	5000	10-30vDC	430mA	230mA	380
114129	114119	Warm White Dimming (Hi CRI)	90+	3000	10-30vDC	480mA	260mA	300
114127	114117	RGBW Spectrum	80+	5000	10-30vDC	430mA	230mA	380

SKU	FINISH	COLOR OUTPUT	CRI*	CCT*	VOLTAGE	12VDC	24VDC	LUMENS†
101033	Brushed	White Non-Dimming	70+	5000	10-30vDC	360mA	180mA	150
101034	Brushed	Blue Non-Dimming	NA	NA	10-30vDC	360mA	180mA	NA
101035	Brushed	Red Non-Dimming	NA	NA	10-30vDC	160mA	100mA	NA
101037	Brushed	RGBW Spectrum	80+	5000	10-30vDC	430mA	230mA	320



9"W x 2"H x 1" D

Available with black housing

Ibiza Engine Room Light

Delivering 1,000 integrating-sphere-measured lumens and dual-color output options, Ibiza is as beautiful as it is brilliant. Designed for the harsh environment of the engine room, Ibiza's carefully engineered optical system delivers a nearly perfect 180-degree beam pattern to illuminate even the farthest, darkest corners. Ignition protected, IP67 compliant, completely sealed, and compatible with most PWM LED dimmers.

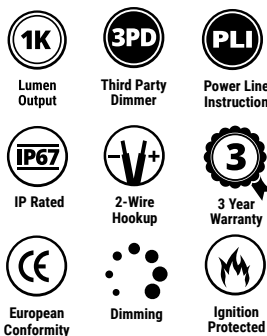

SKU	FINISH	COLOR OUTPUT	CRI*	CCT*	VOLTAGE	12VDC	24VDC	LUMENS†
101520	White	White Non-Dimming	70+	5000	10-30vDC	1.3A	600mA	1000
101521	White	White Dimming, Red Dimming	70+	5000	10-30vDC	1.3A	600mA	1000
101522	White	White Dimming, Blue Dimming	70+	5000	10-30vDC	1.3A	600mA	1000
101532	Black	White Non-Dimming	70+	5000	10-30vDC	1.3A	600mA	1000
101533	Black	White Dimming, Red Dimming	70+	5000	10-30vDC	1.3A	600mA	1000
101534	Black	White Dimming, Blue Dimming	70+	5000	10-30vDC	1.3A	600mA	1000



Nevis2

5.0" W X 2.5" H X 0.63" D

NevisLT

Nevis2/NevisLT Engine Room Light

With more than 1,000 integrating sphere tested lumens†, the Nevis2 and NevisLT douses hard-to-light areas with a 180-degree spread of bright, even light. Available in white/red or white/blue and certified as ignition protected, Nevis is completely sealed, IP67 compliant and compatible with most PWM** LED dimmers. Nevis - still the original, still the best!

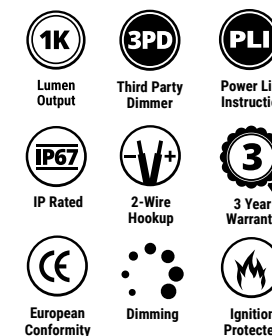

SKU	COLOR OUTPUT	CRI*	CCT*	VOLTAGE	12VDC	24VDC	LUMENS†
Nevis2							
101147	White Dimming, Blue Dimming	70+	5000	10-30vDC	1.3A	600mA	1000
101148	White Dimming, Red Dimming	70+	5000	10-30vDC	1.3A	600mA	1000
NevisLT							
101296	White Non-Dimming	70+	5000	10-30vDC	1.3A	600mA	1000

* Lumens, CRI & CCT applies only to white light.

** Pulse Width Modulation (PWM)

† Integrating sphere measured lumens within 1 minute of initial startup



2" W. X 1" H X 0.43" D



Also available with white or black housing



Fiji Full-Color Courtesy Light

Fiji, our first full-color, 2-wire courtesy light is designed to be used in conjunction with a Poco module to provide unlimited color options at your fingertips (no TTP available). Fiji has a small footprint, no exposed fasteners, and an attractive contemporary design. Available with a direct or indirect light beam pattern and a choice of white, black or a stainless-steel finish. IP 67 rated.

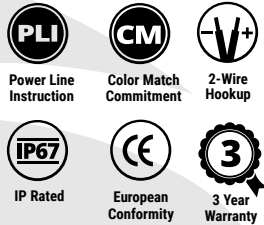

Note: Sold in packs of four (4) lights.

SKU	QUANTITY	FINISH	COLOR OUTPUT	CRI*	CCT*	VOLTAGE	12VDC	LUMENS†
101756	4 per pack	Polished	RGBW Spectrum Direct	70+	5000	10-16vDC	33mA	26
101763	4 per pack	White	RGBW Spectrum Direct	70+	5000	10-16vDC	33mA	26
101758	4 per pack	Black	RGBW Spectrum Direct	70+	5000	10-16vDC	33mA	26
101753	4 per pack	Polished	RGBW Spectrum Indirect	70+	5000	10-16vDC	33mA	5
101754	4 per pack	White	RGBW Spectrum Indirect	70+	5000	10-16vDC	33mA	5
101755	4 per pack	Black	RGBW Spectrum Indirect	70+	5000	10-16vDC	33mA	5

* Lumens, CRI & CCT applies only to white light.
 † Integrating sphere measured lumens within 1 minute of initial startup

Direct Beam Pattern

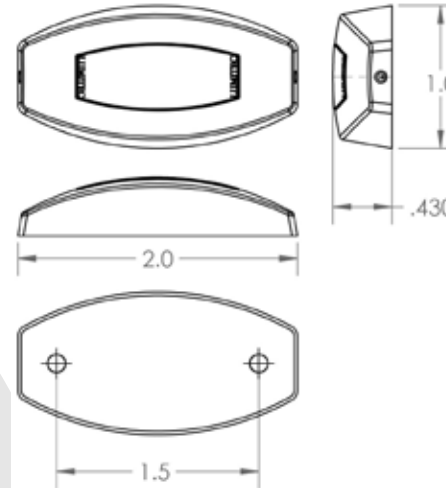

Indirect Beam Pattern

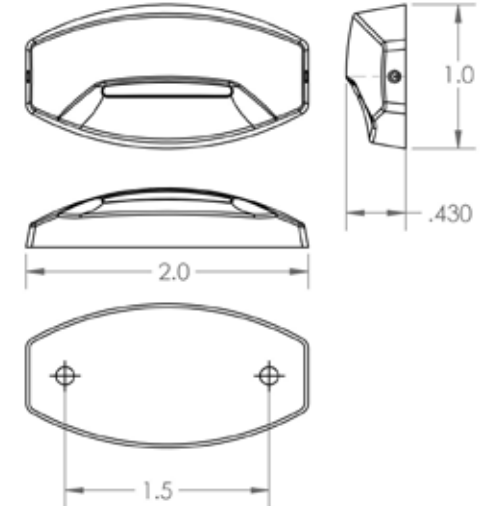

Poco Module Required:

Important: The Fiji courtesy light is required to be connected to a Poco Module for color control (no TTP available).



* Lumens, CRI & CCT applies only to white light.
 † Integrating sphere measured lumens within 1 minute of initial startup

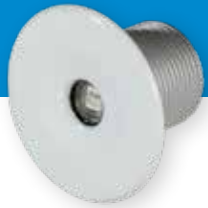

Echo

1.24" Dia. X 0.75" D
Mounting Hole Size: 0.6875" Dia. (11/16)



Andros

1.0" W X 1.0" H X 0.50" D



Exuma

0.98" Dia. X 0.44" D



Aruba

0.93" Dia. X 0.50" D
Mounting Hole Size: 0.6875" Dia. (11/16)



Barbados

1.81" W X 1.15" H X 0.53" D

Courtesy & Accent Lights

Small, attractive, and discreet, these accent lights offer more light output than many "full size" overhead lights. All measure about 1" in diameter or less. Echo is clean, almost flush, and easy to install. Andros and Aruba offer a wide bright indirect beam. Exuma and Barbados are surface mount and fit almost anywhere. All suitable for interior or exterior courtesy and accent lighting needs. Fully sealed, IP67 compliant. Not compatible with Poco module or 24 vDC systems.

TECHNICAL SPECIFICATIONS FOR ALL MODELS

Voltage	10-16vDC
12vDC	45mA
CRI	70+ (White Only)
CCT.....	5000 (White Only)
CCT.....	3000 (Warm White)
Lumens [†]	45 (White Only)



Third Party Dimmer



Color Match Commitment



3 Year Warranty



IP Rated



European Conformity



2-Wire Hookup

	ECHO		ANDROS		EXUMA		ARUBA	BARBADOS
COLOR OUTPUT	BRUSHED	WHITE	POLISHED SS	WHITE	POLISHED SS	WHITE	STAINLESS	BLACK
White Light	112203	112223	101043	101046	101049	101052	101144	101059
Blue Light	112204	112224	101044	101047	101050	101053	101145	101060
Red Light	112205	112225	101045	101048	101051	101054	101146	101061
Warm White	101227	101228	101223	101224	101225	101226	101230	NA

* Lumens, CRI & CCT applies only to white light.

W=Width, H=Height, D=Depth, Dia=Diameter

† Integrating sphere measured lumens within 1 minute of initial startup

Underwater Lighting

Known the world over for their performance and reliability, Lumitec's underwater lighting is the benchmark in the industry. With a wide range of products, a reputation for innovation, and a commitment to quality, Lumitec underwater products will continue to set the standard for many years to come.



All-New SeaBlazeX3™



2024 will see the introduction of the all-new SeaBlazeX3. 7,000+ lumens of output with a lower profile - up to 50% less than the current X2, and a fresh newly designed emitter array. New features will include, for the first time a "Light to Sound" capability when paired with a compatible Poco module. SeaBlazeX3 will retain the same bronze construction and hole pattern as the X2, making upgrades easy and pricing is expected to be comparable to the current model. Production launch date for the new SeaBlazeX3 is estimated to be mid-2024.

6,000+
Lumens

Bronze



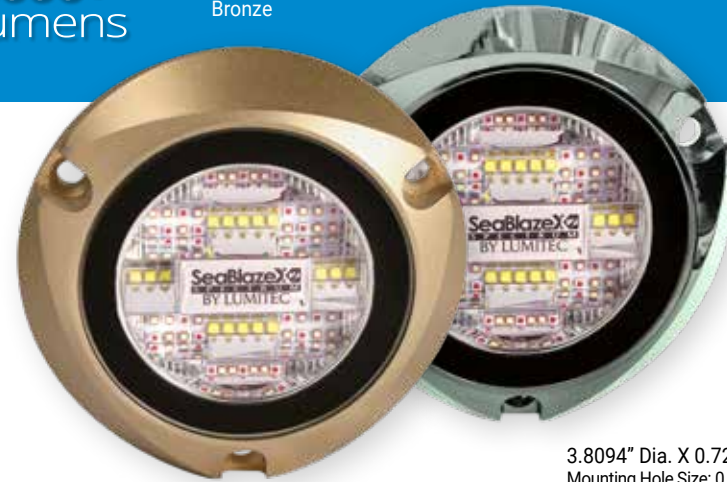





Polished



3.8094" Dia. X 0.72" D
Mounting Hole Size: 0.5" Dia.

SeaBlazeX2™

SeaBlazeX2 continues the legacy of the phenomenally successful SeaBlazeX series. The dual-color SeaBlazeX2 offers an internally synchronized white/blue crossfade mode as well as white or blue color output. The Spectrum offers a nearly limitless palette of intense, vivid colors complemented with a relaxing color cycle mode. Both versions deliver more than 6,000 lumens, easy surface mount installation, require no external drivers, Poco digital lighting control system compatibility, and a pedigree of reliability recognized the world over. SeaBlazeX2 is available with a bronze or polished finish option.

-  **6K**
Lumen Output
-  **RGBW**
Full-Color
-  **TTP**
Timed Toggle Protocol
-  **IP68**
IP Rated
-  **Color Cycle**
-  **PLI**
Power Line Instruction
-  **CE**
European Conformity
-  **Dry Operation**
-  **3**
Year Warranty

SKU	HOUSING	COLOR OUTPUT	CRI*	CCT*	VOLTAGE	12VDC	24VDC	LUMENS†
101516	Bronze	Dual-Color White/Blue	70+	6500	10-30vDC	5A	2.5A	6000+
101592	Polished	Dual-Color White/Blue	70+	6500	10-30vDC	5A	2.5A	6000+
101515	Bronze	RGBW Spectrum	70+	6500	10-30vDC	5A	2.5A	6000+
101591	Polished	RGBW Spectrum	70+	6500	10-30vDC	5A	2.5A	6000+

* Lumens, CRI & CCT applies only to white light.
W=Width, H=Height, D=Depth, Dia=Diameter
† Integrating sphere measured lumens within 1 minute of initial startup

10,000+
Lumens



4.75" Dia. X 5.125" D
Mounting Hole Size: 3.625" Dia.

4" Dia. X 5.125" D
Mounting Hole Size: 3" Dia.

Available as Transom
or Flush Mount Option

SeaBlaze™ Typhoon

Through-Hull Underwater Light

The evolution of the SeaBlaze underwater light series continues with the Typhoon Through-Hull Underwater Light. Typhoon sets a new standard for performance, reliability, and value in through-hull underwater lighting. Delivering more than 10,000 measured lumens (white) and a modular quick-change design for easy in-water service and upgrades. An innovative internal relay simplifies wiring and significantly reduces installation costs and complexity. Solid bronze housing requires a 3" mounting hole (3.625" flush mount). Full-color control using any standard on/off switch or use Lumitec's Poco Digital Lighting Control (sold separately) for even more advanced features.



Lumen
Output



RGBW
Full-Color



Timed Toggle
Protocol



IP Rated



Color Cycle



Power Line
Instruction



European
Conformity



Dry Operation



3 Year
Warranty

SKU	MOUNT	COLOR OUTPUT	CRI*	CCT*	VOLTAGE	12VDC	24VDC	LUMENS†
101448	Transom	Dual-Color White/Blue, Cross Fade	70+	6500	10-30vDC	10A	4.5A	10,000+
101449	Transom	RGBW Spectrum	70+	6500	10-30vDC	10A	4.5A	10,000+
101450	Flush	Dual-Color White/Blue, Cross Fade	70+	6500	10-30vDC	10A	4.5A	10,000+
101451	Flush	RGBW Spectrum	70+	6500	10-30vDC	10A	4.5A	10,000+

8"W X 2" H X 0.67"D
Mounting Hole Size: 0.5" Dia.

6,000+
Lumens



Javelin600X

Style and performance unite to create the Javelin 600X underwater light. Designed for high-performance boats, the Javelin 600X is constructed from a solid naval bronze housing with a proprietary plating process for a brilliant high luster finish. Leveraging the same "smart light" technology found in our market-leading SeaBlazeX2 series - Javelin offers the same high performance, full-color RGBW output, simple surface mount installation, and the ease of operation only found in Lumitec products. Javelin is PLI enabled and fully compatible with our Poco Digital Lighting Control System.



Lumen
Output



RGBW
Full-Color



Timed Toggle
Protocol



IP Rated



Color Cycle



Power Line
Instruction



European
Conformity



Dry Operation



3 Year
Warranty

SKU	HOUSING	COLOR OUTPUT	CRI*	CCT*	VOLTAGE	12VDC	24VDC	LUMENS†
101705	Polished	RGBW Spectrum	70+	6500	10-30vDC	5A	2.5A	6000+

* Lumens, CRI & CCT applies only to white light.

W=Width, H=Height, D=Depth, Dia=Diameter

† Integrating sphere measured lumens within 1 minute of initial startup

2,000+
Lumens



3.80" Dia. X 0.72" D
Mounting Hole Size: 0.5" Dia.

890+
Lumens



2.98" Dia. X 0.63" D
Mounting Hole Size: 0.5" Dia.

Single colors sold as a pair.

750+
Lumens



Power Line Instruction

Spectrum light sold individually.

SeaBlaze™ Quattro

The SeaBlaze Quattro leverages the technology of its big brother, the SeaBlazeX2 in a more cost-effective package. Quattro boasts more than 2,000 lumens, includes a cross fade and color cycle mode, and is constructed of a marine-grade bronze housing with heat-tempered glass. Available in dual-color white/blue or dazzling full-color Spectrum output. The SeaBlaze Quattro is the new standard for high-performance value in underwater lighting.

- 2K**
Lumen Output
- RGBW**
Full-Color
- TTP**
Timed Toggle Protocol
- IP68**
IP Rated
- Color Cycle**
- Dry Operation**
- CE**
European Conformity
- 3**
3 Year Warranty
- 2-Wire**
Hookup

SeaBlaze™ Mini

SeaBlaze Mini packs a surprising punch! Leveraging many of the technologies utilized in our market-leading SeaBlaze series, ensuring years of trouble-free service. Available with a full-color Spectrum (750 lumens*) option that is Poco System compatible there is simply no better value in underwater lighting. SeaBlaze Mini and SeaBlaze Mini Spectrum are perfect for smaller trailer boats, skiffs, or dinghies. Single color lights are sold as a pair.

- RGBW**
Full-Color
- 3PD**
Third Party Dimmer
- TTP**
Timed Toggle Protocol
- IP68**
IP Rated
- Color Cycle**
- Dry Operation**
- CE**
European Conformity
- 2-Wire**
Hookup
- 3**
3 Year Warranty

SKU	HOUSING	COLOR OUTPUT	CRI*	CCT*	VOLTAGE	12VDC	24VDC	LUMENS†
101511	Bronze	Dual Color White/Blue	70+	6500	10-30vDC	2.1A	1.1A	2000
101510	Bronze	RGBW Spectrum	70+	6500	10-30vDC	2.1A	1.1A	2000

SKU	COLOR OUTPUT	CRI*	CCT*	VOLTAGE	12VDC	24VDC	LUMENS†
101245	White Non-Dimming	70+	6500	10-30vDC	990mA	450mA	890
101246	Blue Non-Dimming	NA	NA	10-30vDC	990mA	450mA	NA
101832	RGBW Spectrum	70+	6500	10-30vDC	580mA	320mA	690

* Lumens, CRI & CCT applies only to white light.

W=Width, H=Height, D=Depth, Dia=Diameter

† Integrating sphere measured lumens within 1 minute of initial startup

Surface Mount Underwater Lights

ZAMBEZI™

Zambezi™ is the first underwater light on the market to offer a true surface mount solution. Available in single, dual, or full-color RGBW Spectrum output with a choice of naval bronze or anodized aluminum housings. With three products to choose from, there is a Zambezi™ light to suit every boat and every budget, each with a built-in isolation spacer to prevent galvanic corrosion. For Pontoon Boat and aluminum hull boat owners everywhere Zambezi™





4" Dia. X 1.6" D

6,000+
Lumens



Cable exits from
top of light



4" Dia. X 1.6" D

2,000+
Lumens



3" Dia. X 1.2" D

750+
Lumens



SPECTRUM
COLOR

Zambezi X2™

Surface Mount Underwater Light

The most powerful option of the Zambezi™ Series the Zambezi X2 outputs over 6,000 lumens and is compatible with our award-winning Poco Digital Lighting Control system, providing advance color control via a compatible MFD or connected smart device (Poco module is required). Choose from two color output options, brilliant dual-color white/blue or dazzling full-color Spectrum output. Perfect for mounting on typical transducer/accessory brackets.

Zambezi™ Quattro

Surface Mount Underwater Light

The most powerful option of the Zambezi™ Series the Zambezi X2 outputs over 6,000 lumens and is compatible with our award-winning Poco Digital Lighting Control system, providing advance color control via a compatible MFD or connected smart device (Poco module is required). Choose from two color output options, brilliant dual-color white/blue or dazzling full-color Spectrum output. Perfect for mounting on typical transducer/accessory brackets.

Zambezi™ Mini

Surface Mount Underwater Light

Perfect for smaller pontoons and skiffs, Zambezi Mini is small, easy to mount, easy on the wallet, yet packs a visual punch. Choose single-color or full-color Spectrum. Color selection is simple and can be controlled from a standard power switch, or pair with a Poco module (sold separately) for advanced color control through an on board MFD of connected smart device via the Poco app.

Zambezi X2

SKU	COLOR OUTPUT	CRI*	CCT*	VOLTAGE	12VDC	24VDC	LUMENS†
101708	Dual Color White/Blue, Cross Fade	70+	6500	10-30vDC	5A	2.5A	6000
101700	RGBW Spectrum	70+	6500	10-30vDC	5A	2.5A	6000

Zambezi Quattro

SKU	COLOR OUTPUT	CRI*	CCT*	VOLTAGE	12VDC	24VDC	LUMENS†
101459	Dual Color White/Blue, Cross Fade	70+	6500	10-30vDC	2.1A	1.1A	2000
101460	RGBW Spectrum	70+	6500	10-30vDC	2.1A	1.1A	2000

Zambezi Mini

SKU	COLOR OUTPUT	CRI*	CCT*	VOLTAGE	12VDC	24VDC	LUMENS†
101456	White Non-Dimming	70+	6500	10-30vDC	990mA	450mA	890
101457	Blue Non-Dimming	NA	NA	10-30vDC	990mA	450mA	NA
101833	RGBW Spectrum	70+	6500	10-30vDC	580mA	320mA	690

* Lumens, CRI & CCT applies only to white light.

W=Width, H=Height, D=Depth, Dia=Diameter

† Integrating sphere measured lumens within 1 minute of initial startup



2" Dia. X 2.21" D
Mounting Hole Size: 1.375" Dia.











0.88" Dia. X 0.50" D
Mounting Hole Size: 0.6875" Dia. (11/16)



Lutra Livewell/Utility Light

Bright, durable, and completely water sealed, the Lutra is built for the harsh environment of livewells and fish boxes. With more than four times the lumen output of other livewell lights, Lutra is ideal for today's larger livewells, fish boxes, and splash wells. Full-color spectrum output, PLI and TTP enabled, Lutra is compatible with the Poco Digital Lighting Control system for seamless color integration into any on board lighting scheme. IP68 compliant.

- 
Power Line Instruction
- 
Color Match Commitment
- 
3 Year Warranty
- 
IP Rated
- 
2-Wire Hookup
- 
RGBW Full-Color
- 
European Conformity
- 
Dimming
- 
Color Cycle

SKU	FINISH	COLOR OUTPUT	CRI*	CCT*	VOLTAGE	12VDC	24VDC	LUMENS†
101621	White	RGBW Spectrum	80+	5000	10-30vDC	430mA	230mA	340

Newt Livewell/Utility Light

Small, convenient, and extremely durable, the Newt is the go anywhere fully submersible utility light. Perfect for livewell and splashwell locations, Newt provides just enough light where you need it most. Available in four single-color output options, the Newt is the cost-effective solution for all wet area locations. Completely water sealed, IP68 compliant. 12 vDC system only.

- 
European Conformity
- 
Third Party Dimmer
- 
Color Match Commitment
- 
IP Rated
- 
2-Wire Hookup
- 
3 Year Warranty

SKU	COLOR OUTPUT	CRI*	CCT*	VOLTAGE	12VDC	24VDC	LUMENS†
101084	White, Non-Dimming	70+	5000	10-16vDC	45mA	N/A	45
101085	Blue, Non-Dimming	70+	5000	10-16vDC	45mA	N/A	45
101086	Red, Non-Dimming	70+	5000	10-16vDC	45mA	N/A	45
101240	Warm White, Non-Dimming	90+	3000	10-16vDC	45mA	N/A	45

* Lumens, CRI & CCT applies only to white light.

** Pulse Width Modulation (PWM)

† Integrating sphere measured lumens within 1 minute of initial startup

NEW

Available in 39" with a White or Black Finish



Angler Motorized Base



0.7" Diameter

12" Length is Available on Manual Folding Base ONLY

CONTOUR
SERIES

Masthead 360 All-Round Anchor Combo Light

Stylish and sophisticated the Contour Masthead 360 All-Round Anchor Combo Light takes masthead combo lights to a whole new level. An innovative approach to the design dramatically reduces the lights profile and weight, making this Contour Masthead/Anchor Combo Light the slimmest and lightest on the market. Meeting USCG and NMMA C5 2021 standards, rated to 3 nautical miles the Contour Masthead/Anchor Combo Light is available in a 12" and 39" (1m) length with three mounting options – a motorized base, manual folding base, and antenna mount. Available with a white or black finish. IP67 compliant.

12" lengths are available on the manual folding option only.

SKU	FINISH/MOUNT	COLOR OUTPUT	LENGTH	VOLTAGE	12VDC	24VDC	VISIBILITY
101900	White/Folding	White	12"	10-30vDC	185mA	95mA	3NM
101901	Black/Folding	White	12"	10-30vDC	185mA	95mA	3NM
101902	White/Folding	White	39"	10-30vDC	185mA	95mA	3NM
101903	Black/Folding	White	39"	10-30vDC	185mA	95mA	3NM
101904	White/Antenna	White	39"	10-30vDC	185mA	95mA	3NM
101905	Black/Antenna	White	39"	10-30vDC	185mA	95mA	3NM
101906	White/Motorized	White	39"	10-30vDC	185mA	95mA	3NM
101907	Black/Motorized	White	39"	10-30vDC	185mA	95mA	3NM

Conforms to ABYC A16 Standard
Meets USCG requirements: 0-50 meters vessels



Lockable base design

2.5" Dia X 12" or 39" H

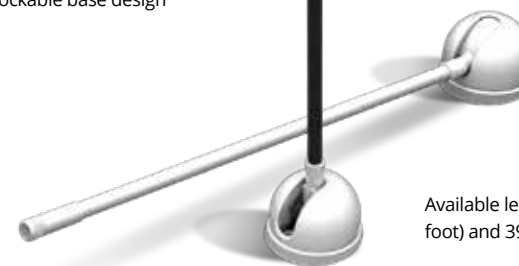

Available lengths: 12" (one foot) and 39" (one meter)

Anchor Light

The Contour Anchor Light has the slimmest profile of any anchor light in the industry with a lightweight design and a locking retractable base. The convenient folding base boasts a small footprint, making for easy storage of the light during transportation. Set the light up in a snap with this innovative simple design and lock the light into position for worry-free use. Available in 12" and 39" (1M) lengths with a white or black shaft. U.S. Coast Guard approved 2nm.



IP Rated



ABYC A16 Standard



2-Wire Hookup



3 Year Warranty

CONTOUR
SERIES

SKU	HOUSING	COLOR OUTPUT	LENGTH	VOLTAGE	12VDC	24VDC	VISIBILITY
101585	Black Shaft	White	12"	10-30vDC	80mA	45mA	2NM
101584	Black Shaft	White	39"	10-30vDC	80mA	45mA	2NM
101692	White Shaft	White	12"	10-30vDC	80mA	45mA	2NM
101693	White Shaft	White	39"	10-30vDC	80mA	45mA	2NM

Conforms to ABYC A16 Standard
Meets USCG requirements: 0-50 meters vessels







USCG
COMPLIANT

Drop-in Mount
2.5" W X 1.17 H X 1.5" D
Requires Custom Mold

Drop-in Navigation Light (Port/Starboard/Stem)

Contour's drop-in series leverages a single, symmetrical universal pocket design that is molded into the hardtop during the manufacturing process, for a low profile with no exposed fasteners. A clean, modern monochromatic finish adds to the seamless integration with careful consideration given to mating the draft angles and part radii. U.S. Coast Guard approved to 2nm.

 IP Rated
 ABYC A16 Standard
 2-Wire Hookup
 3 Year Warranty

CONTOUR
SERIES

SKU	FINISH	COLOR OUTPUT	VOLTAGE	12VDC	24VDC	VISIBILITY
101846	White	Port/Red	10-30vDC	67mA	33mA	2NM
101836	White	Starboard/Green	10-30vDC	34mA	17mA	2NM
101866	White	Stern/White	10-30vDC	50mA	25mA	2NM

Conforms to ABYC A16 and ABYC C-5 Standards
Meets USCG requirements: 0-50 meters vessels



USCG
COMPLIANT

Inset Mount
2.67" W X 1 H X 1.32" D

Inset Navigation Light (Port/Starboard/Stem)

Designed specifically for custom builders, Contour's inset series is designed to be inset into the face of a hardtop or pilothouse with no exposed fasteners. Its small appearance make it almost disappear, but the output is more than large enough to exceed U.S. Coast Guard's 2nm requirements. U.S. Coast Guard approved 2nm for vessels up to 50m/165 feet.

 IP Rated
 ABYC A16 Standard
 2-Wire Hookup
 3 Year Warranty

CONTOUR
SERIES

SKU	FINISH	COLOR OUTPUT	VOLTAGE	12VDC	24VDC	VISIBILITY
101847	White	Port/Red	10-30vDC	67mA	33mA	2NM
101837	White	Starboard/Green	10-30vDC	34mA	17mA	2NM
101867	White	Stern/White	10-30vDC	50mA	25mA	2NM

Conforms to ABYC A16 and ABYC C-5 Standards
Meets USCG requirements: 0-50 meters vessels

* Lumens, CRI & CCT applies only to white light.

W=Width, H=Height, D=Depth, Dia=Diameter

† Integrating sphere measured lumens within 1 minute of initial startup

World's First Nav/Docking Combination Light

Mold Mount
4"W X 1H X 1.8" D
Requires Custom Mold



USCG
COMPLIANT

Combination Navigation/Docking Light

Innovation – plain and simple. Lumitec's engineers have combined a bright, sharp 1,000 lumen dock light with a U.S. Coast Guard approved 2nm navigation light. This innovative, easy to install, great looking, combination light is designed to be molded into the hardtop during the manufacturing process resulting in a very clean profile, and all the reliability you've come to expect from the Lumitec brand.



CONTOUR
SERIES

SKU	FINISH	COLOR OUTPUT	VOLTAGE	12VDC	24VDC	VISIBILITY
101849	White	Port/Red/Flood White	10-30vDC	36mA	18mA	2NM
101839	White	Starboard/Green/Flood White	10-30vDC	25mA	13mA	2NM

Conforms to ABYC A16 and ABYC C-5 Standards
Meets USCG requirements: 0-50 meters vessels

Built-in Floodlight (applies to all SKU numbers)

White Non-Dimming | CRI-70+ | CCT-5000 | Voltage-10-30vDC | 1.3A @12vDC | 600mA @ 24vDC | 1000 Lumens

* Lumens, CRI & CCT applies only to white light.

W=Width, H=Height, D=Depth, Dia=Diameter

† Integrating sphere measured lumens within 1 minute of initial startup

Composite Navigation Light



4.5"W X 1H X 2.1" D

USCG
COMPLIANT

Classic Aluminum Navigation Light



3.6"W X 1H X 2.2" D

Surface Mount Navigation Lights

For retrofit and new applications where a molded-in pocket is not possible or practical, we offer our surface mount navigation lights. Clean styling and unmatched reliability. Choose classic aluminum half-round design for mounting to vertical surfaces, or the more contemporary composite version for horizontal mounting surfaces. U.S. Coast Guard approved 2nm for vessels up to 50m/165 feet.



Composite Navigation Light

SKU	FINISH	COLOR OUTPUT	VOLTAGE	12VDC	24VDC	VISIBILITY
101848	White	Port/Red	10-30vDC	67mA	33mA	2NM
101838	White	Starboard/Green	10-30vDC	34mA	17mA	2NM
101868	White	Stern/White	10-30vDC	50mA	25mA	2NM

Conforms to ABYC A16 and ABYC C-5 Standards
Meets USCG requirements: 0-50 meters vessels

Classic Aluminum Navigation Light

SKU	FINISH	COLOR OUTPUT	VOLTAGE	12VDC	24VDC	VISIBILITY
101845	Brushed	Port/Red	10-30vDC	34mA	17mA	2NM
101835	Brushed	Starboard/Green	10-30vDC	67mA	33mA	2NM

Conforms to ABYC A16 and ABYC C-5 Standards
Meets USCG requirements: 0-50 meters vessels



Dock & Deck Lighting Systems

Lumitec's Dock and Deck lights deliver the performance, reliability, and overall good looks that only the world-leader in marine lighting could deliver. With plug-and-play solutions for the do-it-yourselfer to a completely customizable modular system for commercial applications, Lumitec's Dock and Deck lighting will dramatically transform any outdoor waterfront space.



4" Dia. X 2.1" D



Mantis™ Dock Lighting Kit

The Mantis Dock Light Kit leverages the cutting-edge Quattro Spectrum underwater light (3 lights included), but adds an innovative zip-mount universal mounting system for ease of installation - lights mount easily to square or round pilings. Select a mesmerizing full-color RGBW crossfade, bright fish-attracting white (2000+ lumens), or virtually any user-selected color output. The 150w power supply is housed in a durable weatherproof enclosure (4 light max) and will conveniently plug into any standard 110vAC GFCI outlet (110vAC only*). All wiring, connectors, light mounts, and hardware are included. 3-year warranty on electrical parts.

Lumen
OutputRGBW
Full-ColorTimed Toggle
Protocol

IP Rated



Color Cycle



Color Change



Dry Operation

3
Year
Warranty

SKU	DESCRIPTION	NUMBER OF LIGHTS
101525	Mantis Dock Light Kit (110vAC only)	3
101526	Mantis Dock Light Add-On Light	1
101527	Mantis Dock Light 50' Cable Extension Kit	N/A

* The Mantis Dock Light Kit can only be connected to 110vAC and not 220vAC. 220vAC custom kits are available upon request. Contact your sales representative for more product information.

The Mantis Dock Light Kit leverages SeaBlaze Quattro technology. Refer to the underwater light section for specifications on this light.



4" Dia. X 2.1" D

Wireless Control

Smartphone
Not IncludedKraken Command
Box includes Poco
module and 480w
power supply.

Kraken™ Dock Lighting System

The Kraken Dock Lighting System is carefully designed to be powerful and robust enough for most commercial applications, but versatile enough for larger residential installations. One Kraken Command Box (110vAc or 220vAC compatible) powers and controls up to six (6) Kraken underwater lights (sold separately), each outputting more than 6,000 lumens (white output). Kraken underwater lights are based on our field-proven SeaBlazeX2 platform and are available in dual-color white/blue, or full-color RGBW output. Add the Nautilus Piling Light and Scallop Pathway Light for walkways and decks, and control it all from your smartphone, tablet, or connected smart device.

Lumen
OutputRGBW
Full-ColorTimed Toggle
Protocol

IP Rated



Color Cycle

Power Line
Instruction

Color Change

3
Year
Warranty

SKU	DESCRIPTION	NUMBER OF LIGHTS
101636	Kraken Dock Light - dual color white/blue	1
101637	Kraken Dock Light - RGBW Spectrum	1
101638	Kraken Command Box (with Poco)	N/A
101680	Kraken Secondary Box (no Poco)	N/A

The Kraken Dock Light System leverages SeaBlazeX2 technology. Refer to the underwater light section for specifications on this light.



Polished Stainless Steel

4" Dia. X 0.6" D



Polished Bronze

Scallop

Surface Mount Pathway Light

With a sleek, low-profile design Lumitec's Scallop Pathway Light is the world's first ADA-compliant, PLI-compatible, dock, and pathway light. The carefully engineered beam-angle minimizes glare while illuminating walkway surfaces. Scallop is available in a hand-polished 316 stainless steel or hand-polished bronze finish. Choose from warm white or RGBW full-color output. The Scallop light is PLI and TTP enabled, meaning it can be added to a Mantis dock light kit or designed into a Kraken dock light system. Completely water sealed and IP67 compliant.

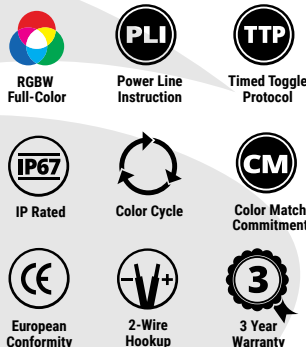

SKU	HOUSING	COLOR OUTPUT	CRI*	CCT*	VOLTAGE	12VDC	24VDC	LUMENS†
101627	Stainless Steel	Spectrum (cool wht)	70+	5000	10-30vDC	340mA	190mA	100
101628	Bronze	Spectrum (cool wht)	70+	5000	10-30vDC	340mA	190mA	100
101672	Stainless Steel	Spectrum (warm wht)	80+	3000	10-30vDC	340mA	190mA	80
101673	Bronze	Spectrum (warm wht)	80+	3000	10-30vDC	340mA	190mA	80
101629	Stainless Steel	White (warm wht)	80+	3000	10-30vDC	340mA	190mA	80
101630	Bronze	White (warm wht)	80+	3000	10-30vDC	340mA	190mA	80



Polished Stainless Steel

1.6" W X 4.2" H X 1.5" D



Polished Bronze

Nautilus

Surface Mount Piling Light

Small, clean, and versatile, Nautilus is perfect for pilings, posts, pathways, and wall-wash applications. Surface mountable with included adapter for curved for flat mounting locations. Nautilus is available in a hand-polished 316 stainless steel or hand-polished bronze finish. Choose from warm white or RGBW full-color output. The Nautilus light is PLI and TTP enabled, meaning it can be added to a Mantis dock light kit or designed into a Kraken dock light system. Completely water sealed and IP67 compliant.



SKU	HOUSING	COLOR OUTPUT	CRI*	CCT*	VOLTAGE	12VDC	24VDC	LUMENS†
101631	Stainless Steel	Spectrum (cool wht)	80+	5000	10-30vDC	430mA	230mA	340
101632	Bronze	Spectrum (cool wht)	80+	5000	10-30vDC	430mA	230mA	340
101670	Stainless Steel	Spectrum (warm wht)	80+	3000	10-30vDC	430mA	230mA	255
101671	Bronze	Spectrum (warm wht)	80+	3000	10-30vDC	430mA	230mA	255
101633	Stainless Steel	White (warm wht)	80+	3000	10-30vDC	480mA	260mA	255
101634	Bronze	White (warm wht)	80+	3000	10-30vDC	480mA	260mA	255

* Lumens, CRI & CCT applies only to white light. W=Width, H=Height, D=Depth, Dia=Diameter
 † Integrating sphere measured lumens within 1 minute of initial startup

Power Supply

A 150w power supply is available for above water lighting.
SKU: 101528





Above Water Dock Lighting

No Dock lighting project is complete without the addition of above water lights. Lumitec offers the durability found in our marine lights with seamless integration, whether you go with a Kraken Modular System or the Plug 'N' Play Mantis Kit.

A photograph of a boat's outboard motor at night. The motor is white and illuminated with a bright green light. The water is dark blue, and the sky is a mix of orange and blue, suggesting a sunset or sunrise. The text "| BOW TO STERN LIGHTING SOLUTIONS |" is overlaid in white on the image.

| BOW TO STERN LIGHTING SOLUTIONS |

Customer Support

Lumitec's phenomenal growth is due in large part to our ever-growing base of loyal OEMs, channel partners, and end-users. We take this loyalty very seriously and strive to ensure that each interaction with Lumitec is a rewarding and satisfying one.

Our website includes a comprehensive "Support Center." Here, you will find Frequently Asked Questions, installation guides, technical details, wiring information, product use videos, and other invaluable product information just a click away.

TEL. 561.272.9840

FAX. 561.272.9839

WEB. LUMITECLIGHTING.COM

1055 SW 15TH AVENUE, SUITE 7
 DELRAY BEACH, FLORIDA 33444

Feature Icons



Timed Toggle Protocol (TTP) enabled
 (visit lumiteclighting.com/support/ttp for information)



RGBW Spectrum Color



Third Party Dimmer switch compatibility
 (PWM type dimmer required)



Internal Dimmer- TTP dimming
 with no external controllers



Color Match guarantee between all lights



Color Cycle mode



Power Line Instruction (PLI) enabled
 (visit lumiteclighting.com/pli for information)



Strobe or Flashing feature



Ingress Protected (IP) product rating



Ignition Protected



Meets European Conformity Standards



Dry Operation - light can operate
 out of water without damage



3-Year warranty



Color Change mode

Lumitec Limited Warranty

Our products are warrantied to be free from defects in workmanship and materials for a period of three (3) years from the date of original purchase. Should your Lumitec product prove defective during the warranty period, promptly notify Lumitec and return product with freight prepaid. Lumitec will, at its option, repair or replace the product without charge for parts or labor or refund purchase price. Products repaired or replaced under this warranty shall be warrantied for the unexpired portion of the warranty applying to the original product(s). Lumitec is not responsible for product failure caused by abuse, neglect, improper installation, or failure in applications other than those for which it was designed, intended, and marketed. No warranty or affirmation of fact, express or implied, other than as set forth in the limited warranty statement above is made or authorized by Lumitec. Any liability for consequential and incidental damages is expressly disclaimed. Lumitec liability in all events is limited to, and shall not exceed, the purchase price paid.



Tel. 561.272.9840
Fax. 561.272.9839
Web. lumiteclighting.com
1055 SW 15th Avenue, Suite 7
Delray Beach, Florida 33444

| PERFORMANCE | RELIABILITY | QUALITY |